

SECTION 4B

REAR AXLE

NOTICE: All rear axle attaching fasteners are an important attaching part in that they could affect the performance of vital parts and systems, and/or could result in major repair expense. It must be replaced with one of the same part number or with an equivalent part if replacement becomes necessary. Do not use a replacement part of lesser quality or substitute design. Torque values must be used as specified during reassembly to assure proper retention of this part.

CONTENTS

General Information			
Standard Rear Axle	4B-1	Rear Axle Assembly	4B-12
Limited Slip Rear Axle	4B-2	Unit Repair	4B-12
Disc Type	4B-2	Standard Rear Axle	
Cone Type	4B-2	Rear Axle Case	4B-13
Rear Axle Identification	4B-2	Side Bearing Shim Selection	4B-14
Maintenance and Lubrication	4B-2	Rear Axle Backlash	4B-15
Limited Slip Conversion Information	4B-3	Side Bearing Preload and Case	
Diagnosis	4B-3	Installation	4B-15
Rear Axle Noises	4B-3	Drive Pinion, Bearings and Races	4B-16
Limited Slip Rear Axle	4B-4	Rear Pinion Bearing	4B-17
Diagnosis Chart	4B-5	Front Pinion Bearing	4B-17
Pre-Repair Diagnosis	4B-7	Pinion Depth	4B-17
On-Car Service		Limited Slip Rear Axle	
Rear Axle Flushing Procedure	4B-8	Rear Axle Case	
Carrier Cover Gasket	4B-8	Disc Type	4B-18
Axle Shaft	4B-8	Cone Type	4B-21
Axle Oil Seal and/or Bearing	4B-8	Specifications	4B-24
Pinion Yoke Oil Seal	4B-10	Special Tools	4B-25
Pinion Yoke	4B-11	Rear Axle Usage Chart	4B-27

GENERAL INFORMATION

STANDARD REAR AXLE

See Figure 1

The rear axle assembly is of the semifloating type in which the car weight is carried on the axle housing. The rear axle assembly is designed for use with an open drive line and coil springs. The rear axle has a hypoid type ring gear and pinion with the centerline of the pinion gear below the centerline of the ring gear.

All parts necessary to transmit power from the propeller shaft to the rear wheels are enclosed in an axle housing. A removable steel cover bolted to the rear of the carrier permits service of the rear axle without removing the entire assembly from the car.

A universal joint connects the rear end of the propeller shaft to a pinion yoke, having a splined end which fits over and drives the hypoid pinion gear. Two preloaded tapered roller bearings support the hypoid pinion gear in the carrier. The inner race of the rear bearing is a tight press fit on the pinion stem. The inner race of the front bearing combines a light press fit to a close sliding fit on the pinion flange end of the pinion stem. The outer race of each bearing is pressed against a shoulder recessed in the carrier. Tightening the pinion nut compresses a collapsible spacer which bears against the inner race of the front bearing and a shoulder on the pinion stem. This spacer is used to

enable automatic bearing preload adjustment and maintain a preload on both front and rear pinion bearings. Adjustment of the fore and aft position of the pinion is obtained by placing shims between the head of the drive pinion and the rear pinion bearing. The rear axle case is of one-piece construction and is supported in the carrier by two tapered roller side bearings. These are preloaded by inserting shims between the bearings and the carrier. The rear axle case assembly is positioned for proper ring gear to pinion backlash by varying the shim thickness from side to side. The ring gear is bolted to the case. Two side gears have splined bores for driving the axle shafts. They are positioned to turn in counterbored cavities in the case. The two rear axle pinions have smooth bores and are held in position by a solid pinion cross shaft, mounted and locked in the rear axle case. All four gears are in mesh with each other and, because the pinion gears turn freely on their shaft, they act as idler gears when the rear wheels are turning at different speeds. The pinions and side gears are backed by steel thrust washers.

When the car turns a corner, the outer rear wheel must turn faster than the inner wheel. The inner wheel turning slower with respect to the outer wheel, slows its rear axle side gear (as the axle shaft is splined to the side gear) and the rear axle pinion gears will roll around the slowed rear axle side gear, driving the other rear axle side gear and wheel faster.

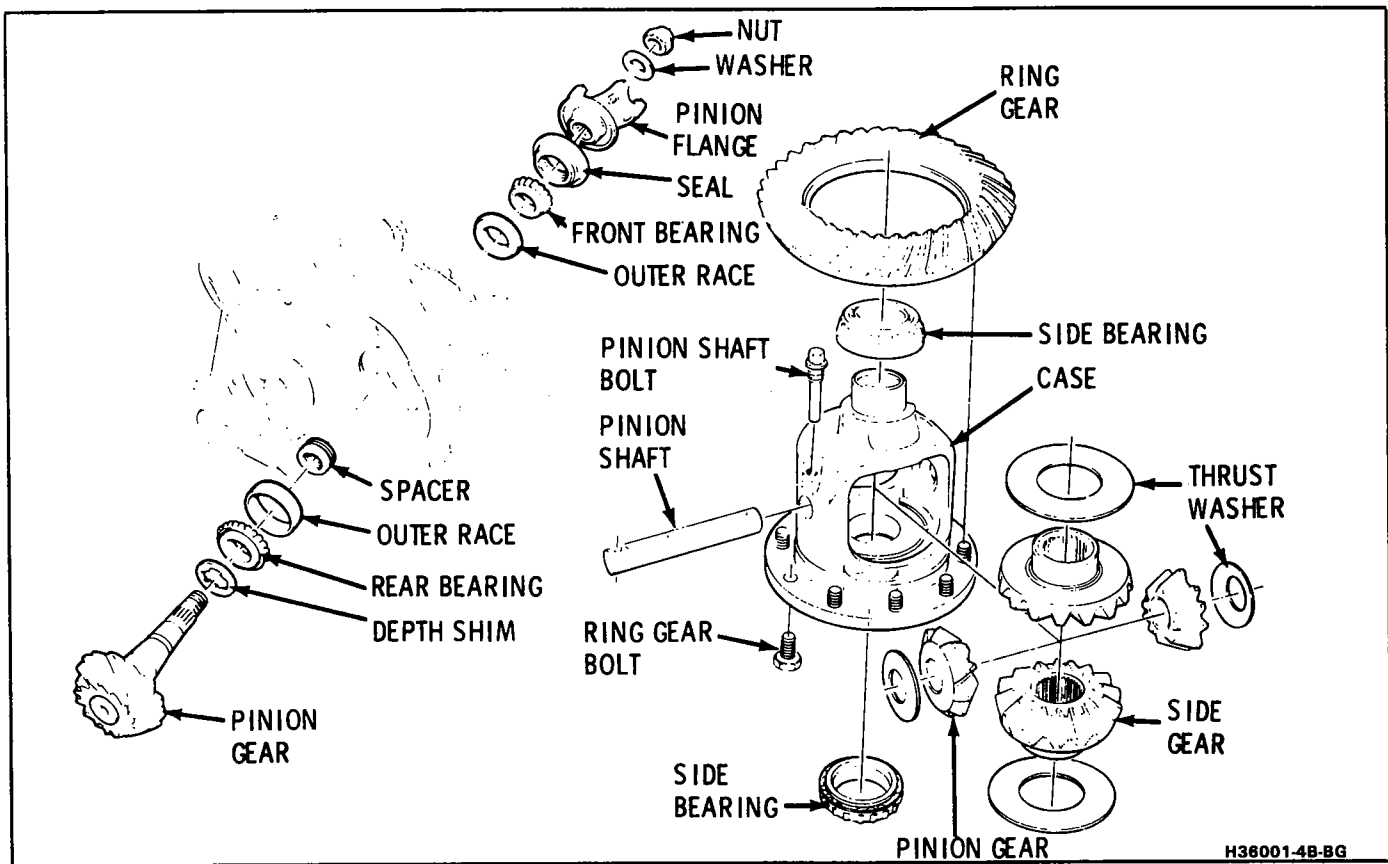

Figure 1 Standard Rear Axle

LIMITED SLIP REAR AXLE

Limited slip rear axles have several definite operating characteristics. An understanding of these characteristics is necessary as an aid to diagnosis.

The energizing force comes from the thrust side of the gears. Consequently, a free spinning wheel may not have enough resistance to driving torque to apply the clutch packs or cones. If this occurs, apply the parking brake a few notches which will provide enough resistance to energize the clutch pack or cones.

Energizing the clutch packs or cones is independent of acceleration; therefore, a very slow application of the throttle on starting is recommended to provide maximum traction by preventing "break away" of either rear wheel.

Disc Type

The limited slip rear axle transmits torque from the drive pinion gear to the ring gear and to the case in the same manner as the conventional rear axle. In addition, the limited slip rear axle incorporates the use of clutch plates which tend to lock the axle shafts to the case, or in effect, to each other.

As driving torque is developed at the rear wheels, side gear separating loads are developed which load the rear axle clutch packs. This induced clutch torque capacity resists relative motion between the side gears and the rear axle case. Therefore, if one wheel is on slippery pavement, such as ice or snow, the other wheel must develop considerably more torque before the case assembly will differentiate and allow wheel spin.

The axle shaft torque developed when turning a corner will overcome the clutch capacity and allow differentiation.

Cone Type

All rear axle parts of cars equipped with the limited slip rear axle are interchangeable with those equipped with the conventional rear axle, except for the case assembly. It is similar in all respects to the conventional case assembly, with the addition of cone clutches splined to each side gear.

REAR AXLE IDENTIFICATION

See Figure 2

The rear axle identification code and manufacturer's code must be known before attempting to adjust or repair axle shafts or rear axle case assembly. Rear axle ratio, differential type, manufacturer, and build date information is stamped on the right axle tube on the forward side, or is stamped on a metal tag by carrier cover.

MAINTENANCE AND LUBRICATION

Limited slip differentials should have the fluid drained and refilled at the first 7,500 miles (12 000 km). Be sure to use limited slip additive 1052358. If a car is used to pull a trailer, change lubricant every 7,500 miles (12 000 km) in either type differential.

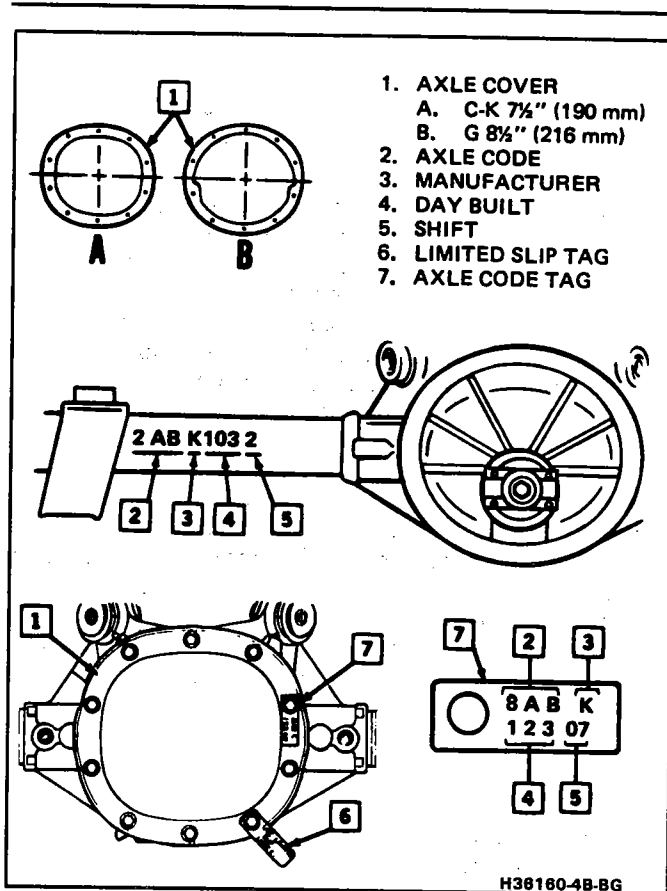

Figure 2 Rear Axle Identification

LIMITED SLIP CONVERSION INFORMATION

The case assembly (less ring gear and side bearings) is available for converting a conventional rear axle to limited slip. The ring gear and side bearings of the conventional rear axle, if in good condition, can be used with the limited slip case assembly.

DIAGNOSIS

Many noises reported as coming from the rear axle actually originate from other sources such as tires, road surfaces, wheel bearings, engine, transmission, muffler or body drumming. A thorough and careful check should be made to determine the source of the noise before disassembling the rear axle. Noise which originates in other places cannot be corrected by adjustment or replacement of parts in the rear axle. It should also be remembered that rear axle gears, like any other mechanical device, are not absolutely quiet and should be accepted as being commercially quiet unless some abnormal noise is present.

To make a systematic check for axle noise under standard conditions, observe the following:

1. Select a level asphalt road to reduce tire noise and body drumming.
2. Check rear axle lubricant to assure correct level, then drive car far enough to thoroughly warm up rear axle lubricant.
3. Note speed at which noise occurs. Then stop car and with automatic transmission in neutral, run engine slowly up and down through engine speeds, corresponding to car speed at which noise

was most pronounced, to determine if it is caused by exhaust, muffler roar or other engine conditions.

4. Tire noise changes with different road surfaces, but rear axle noise does not. Temporarily inflating all tires to approximately 345 kPa (50 psi) for test purposes only, will materially alter noise caused by tires, but will not affect noise caused by rear axle. Rear axle noise usually stops when coasting at speeds under 30 mph; however, tire noise continues, but with lower tone, as car speed is reduced. Rear axle noise usually changes when comparing drive and coast, but tire noise remains about the same.

Distinguish between tire noise and rear axle noise by noting if noise varies with various speeds or sudden acceleration and deceleration; exhaust and axle noise show variations under these conditions while tire noise remains constant and is more pronounced at speeds of 20 to 30 mph. Further check for tire noise by driving car over smooth pavements or dirt roads (not gravel) with tires at normal pressure. If noise is caused by tires, it will noticeably change or disappear and reappear with changes in road surface.

5. Loose or rough front wheel bearings will cause noise which may be confused with rear axle noises; however, front wheel bearing noise does not change when comparing drive and coast. Light application of brake while holding car speed steady will often cause wheel bearing noise to diminish, as this takes some weight off the bearing. Front wheel bearings may be easily checked for noise by jacking up the wheels and spinning them, also by shaking wheels to determine if bearings are loose.
6. Rear suspension rubber bushings and spring insulators dampen out rear axle noise when correctly installed. Check to see that no metallic contact exists between the spring and spring opening in frame or between upper and lower control arm bushings and frame or axle housing brackets. Metal-to-metal contact at those points may result in telegraphing road noise and normal axle noise which would not be objectionable if dampened by bushings.
7. Check to ensure that the floor of body is not in metallic contact with frame.

Rear Axle Noises

Gear Noise

After the noise has been determined as being in the axle by following the above appraisal procedure, the type of axle noise should be determined to aid in making repairs if necessary.

Gear noise (whine) is audible from 20 to 55 mph under four driving conditions:

1. Drive – Acceleration or heavy pull.
2. Road Load – Car driving load or constant speed.
3. Float – Using enough throttle to keep the car from driving the engine car slows down gradually but engine still pulls slightly.

- Coast – Throttle closed and car in gear. Gear noise most frequently has periods where noise is more prominent, usually 30 to 40 mph and 50 to 55 mph.

Bearing Noise

Bad bearings generally produce more of a rough growl or grating sound, rather than the whine typical of gear noise. Bearing noise frequently “wow-wows” at constant bearing rpm, indicating a defective pinion or rear axle side bearing. This noise could easily be confused with rear wheel bearing noise. Inspect and replace as required.

Rear Wheel Bearing Noise

See Figure 4

A rough rear wheel bearing produces a noise which continues with car coasting at low speed and transmission in neutral. Noise may diminish some by gentle braking. With rear wheels jacked up, spin rear wheels by hand while listening at hubs for evidence of rough (noisy) wheel bearing.

Knock At Low Speeds

Low speed knock can be caused by worn universal joints or a side gear hub counterbore in case worn oversize. Inspect and replace universal joint or case and side gear as required.

Backlash Clunk

Excessive clunk with acceleration and deceleration is caused by worn rear axle pinion shaft, worn case, excessive clearance between axle shaft and side gear splines, excessive clearance between side gear hub and counterbore in case, worn pinion and side gear teeth, worn thrust washers and excessive drive pinion and ring gear backlash. Remove worn parts and replace as required, selecting close fitting parts when possible. Adjust pinion and ring gear backlash.

Limited Slip Rear Axle

Improper operation is generally indicated by clutch slippage or grabbing. Sometimes this produces a chatter or whirring sound. However, these sounds are not always indicative of failure as they could be produced from a lack of proper lubrication. For example, under certain conditions where one wheel is on a very slippery surface the other on dry pavement, wheel spin can occur if hard acceleration is attempted. Continued spinning may cause audible noise, such as a whirring sound, due to the clutches or cones lacking

sufficient lubricant. This does not necessarily indicate failure of the unit.

During regular operation (straight ahead driving) when both wheels rotate at equal speeds, there is an equal driving force delivered to each wheel. When cornering, the inside wheel requires extra driving force causing slippage in both clutch packs. Consequently, the operational life of the limited slip unit is dependent upon equal rotation of both wheels during straight ahead operation. If wheel rotation for both rear wheels is not equal during straight ahead operation, the limited slip unit will constantly be functioning as if the car were cornering. This will impose constant slippage on the clutch packs and will eventually lead to abnormal wear on the clutch pack or cone. Therefore, it is important that there be no excessive differences in the rear wheel tire sizes, air pressures, or tire wear patterns. One indication of this condition is “swerving on acceleration”. If swerving on acceleration is encountered, check the rear wheels for different tire size, air pressure, or excessively different wear patterns, and tread depths, before proceeding into an overhaul operation.

Checking Limited Slip Operation

See Figure 3

- Place transmission in “Park” position, parking brake released.
- Raise both rear tires off the floor.
- Remove hub cap or wheel disc and apply a torque wrench as shown.
- Measure torque required to turn one wheel. If the torque reading is less than 48 N·m (35 lbs. ft.), the unit should be disassembled and repaired as required.

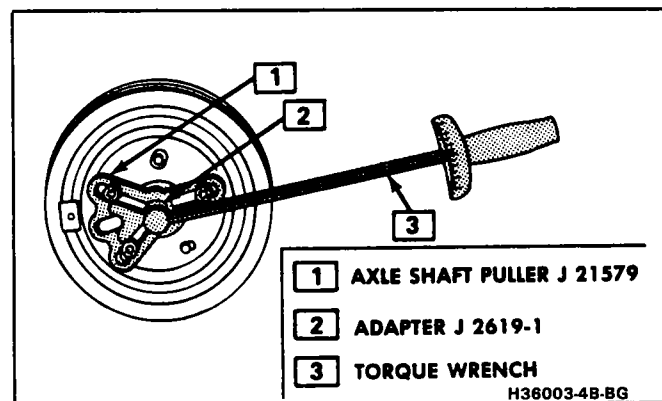
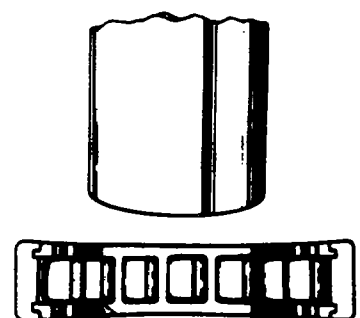
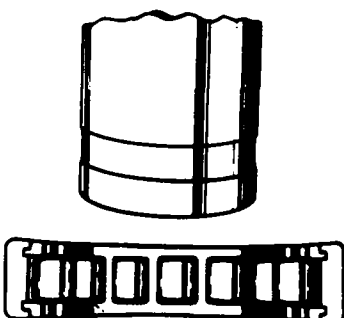
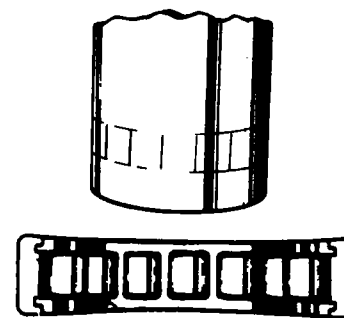
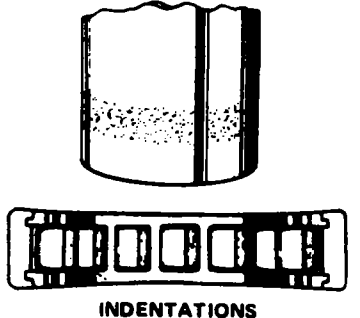
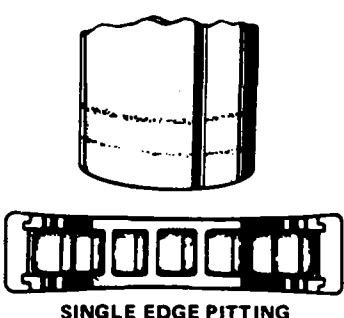
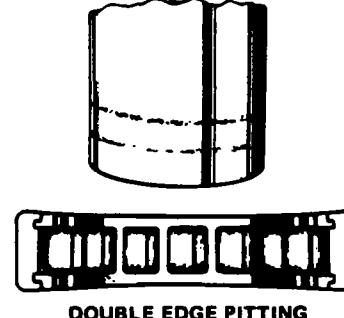
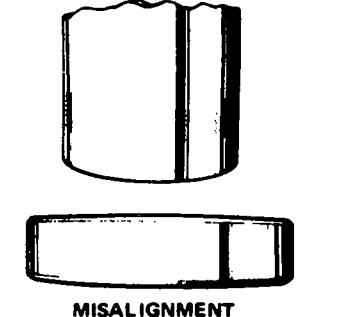
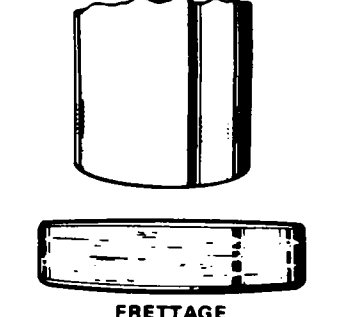
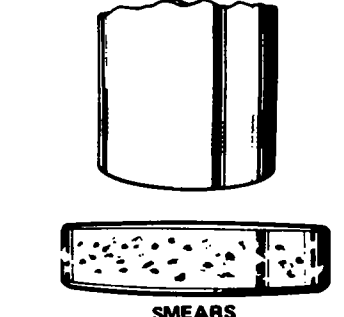

Figure 3 Measuring Limited Slip Rotating Torque

REAR AXLE BEARING DIAGNOSIS

 <p>WEAR (MINOR)</p> <p>LIGHT PATTERN ON RACES AND ROLLERS CAUSED BY FINE ABRASIVES.</p> <p>CLEAN ALL PARTS AND HOUSINGS. CHECK SEALS AND REPLACE BEARINGS IF ROUGH OR NOISY.</p> <p>REPLACE SHAFT IF DAMAGED</p>	 <p>WEAR (MAJOR)</p> <p>HEAVY PATTERN ON RACES AND ROLLERS CAUSED BY FINE ABRASIVES.</p> <p>CLEAN ALL PARTS AND HOUSINGS. CHECK SEALS AND REPLACE BEARINGS IF ROUGH OR NOISY.</p> <p>REPLACE SHAFT IF DAMAGED</p>	 <p>BRINELLING</p> <p>SURFACE INDENTATIONS IN RACEWAY CAUSED BY ROLL EITHER UNDER IMPACT LOADING OR VIBRATION WHILE THE BEARING IS NOT ROTATING.</p> <p>REPLACE BEARING IF ROUGH OR NOISY.</p> <p>REPLACE SHAFT IF DAMAGED</p>
 <p>INDENTATIONS</p> <p>SURFACE DEPRESSIONS ON RACE AND ROLLERS CAUSED BY HARD PARTICLES OF FOREIGN MATERIAL.</p> <p>CLEAN ALL PARTS AND HOUSINGS. CHECK SEALS AND REPLACE BEARINGS IF ROUGH OR NOISY.</p> <p>REPLACE SHAFT IF DAMAGED</p>	 <p>SINGLE EDGE PITTING</p> <p>FLAKING OF SURFACE METAL RESULTING FROM FATIGUE, USUALLY AT ONE EDGE OF RACE AND ROLLERS.</p> <p>REPLACE BEARING - CLEAN ALL RELATED PARTS.</p> <p>REPLACE SHAFT IF DAMAGED</p>	 <p>DOUBLE EDGE PITTING</p> <p>FLAKING OF SURFACE METAL RESULTING FROM FATIGUE, USUALLY AT BOTH EDGES OF RACE AND ROLLERS.</p> <p>REPLACE BEARING - CLEAN ALL RELATED PARTS.</p> <p>REPLACE SHAFT IF DAMAGED</p>
 <p>MISALIGNMENT</p> <p>REPLACE BEARING AND MAKE SURE RACES ARE PROPERLY SEATED.</p> <p>REPLACE SHAFT IF BEARING OPERATING SURFACE DAMAGED.</p>	 <p>FRETTAGE</p> <p>CORROSION SET UP BY SMALL RELATIVE MOVEMENT OF PARTS WITH NO LUBRICATION.</p> <p>REPLACE BEARING. CLEAN RELATED PARTS. CHECK SEALS AND CHECK FOR PROPER FIT AND LUBRICATION.</p> <p>REPLACE SHAFT IF DAMAGED.</p>	 <p>SMEARS</p> <p>SMEARING OF METAL DUE TO SLIPPAGE. SLIPPAGE CAN BE CAUSED BY POOR FITS. LUBRICATION, OVERHEATING, OVERLOADS OR HANDLING DAMAGE.</p> <p>REPLACE BEARINGS, CLEAN RELATED PARTS AND CHECK FOR PROPER FITS AND LUBRICATION.</p>

H36004-4B-BG

Figure 4 Rear Wheel Bearing Diagnosis

REAR AXLE STANDARD AND LIMITED SLIP DIAGNOSIS

Condition	Cause
1. Noise is the same in drive or coast	<ul style="list-style-type: none"> a. Road noise b. Tire noise c. Front wheel bearing noise d. Incorrect driveline angles
2. Noise changes on a different type of road	<ul style="list-style-type: none"> a. Road noise b. Tire noise
3. Noise tone lower as car speed is lowered	<ul style="list-style-type: none"> a. Tire noise
4. Noise is produced with car standing and driving	<ul style="list-style-type: none"> a. Engine noise b. Transmission noise
5. Vibration	<ul style="list-style-type: none"> a. Rough rear wheel bearing b. Unbalanced or damaged propeller shaft c. Tire unbalance d. Worn universal joint in propeller shaft e. Incorrect driveline angles f. Mis-indexed propeller shaft at pinion yoke g. Pinion yoke runout too great
6. A knock or click approximately every two revolutions of rear wheel	<ul style="list-style-type: none"> a. Rear wheel bearing
7. Noise most pronounced on turns	<ul style="list-style-type: none"> a. Rear axle side gear and pinion noise
8. A continuous low pitch whirring or scraping noise starting at relatively low speed	<ul style="list-style-type: none"> a. Pinion bearing noise
9. Drive noise, coast noise or float noise	<ul style="list-style-type: none"> a. Ring and pinion gear noise
10. Clunk on acceleration or deceleration	<ul style="list-style-type: none"> a. Worn rear axle pinion shaft in case or side gear hub counterbore in case worn oversize b. Worn universal joint in propeller shaft c. Slip yoke
11. Groan in forward or reverse	<ul style="list-style-type: none"> a. Wrong lubricant in rear axle
12. Chatter on turns	<ul style="list-style-type: none"> a. Wrong lubricant in rear axle b. Clutch plates worn
13. Clunk or knock on rough road operation	<ul style="list-style-type: none"> a. Excessive end play of axle shafts

PRE-REPAIR DIAGNOSIS

A close examination of the differential prior to disassembly will often reveal valuable information as to the extent and type of repairs or adjustments necessary. The information thus gained, coupled with the report of the malfunction, will provide a basis for determining the degree of disassembly required. Frequent cause of axle noise are improper backlash, pinion bearing preload, or side bearing preload, or a combination of these items. A few simple adjustments may be all that are necessary to correct the problem.

Therefore, before removing the rear axle from the housing, the following checks should be made with the results recorded and analyzed: 1) Backlash; 2) Total Assembly Preload; and 3) Tooth Contact Pattern.

Use care at all times to keep dirt and other foreign matter, such as grinder dust, soot, or sand, away from rear axle to prevent possibility of subsequent failure.

The pinion and ring gear must be completely assembled, installed, and all preload and backlash adjustments completed prior to the start of this method of pinion depth setting. The following procedure can be used in place of the gage method of pinion depth setting.

Gear Tooth Nomenclature

See Figure 5

The side of the ring gear tooth which curves outward, or is convex, is referred to as the "drive" side. The concave side is the "coast" side. The end of the tooth nearest center of ring gear is referred to as the "toe" end. The end of the tooth farthest away from center is the "heel" end. Toe end of tooth is smaller than heel end.

It is very important that tooth contact be tested before the rear axle carrier assembly is disassembled. Variations in the carrier or pinion rear bearing may cause the pinion to be too far away from, or close to, the ring gear. Thus, the tooth contact must be tested and corrected, if necessary, or the gears may be noisy.

Tooth Contact Pattern Test

See Figures 5 and 6

1. Wipe oil out of carrier and carefully clean each tooth of ring gear.
2. Use gear marking compound 1052351 or equivalent and apply this mixture sparingly to all ring gear teeth, using a medium stiff brush. When properly used, the area of pinion tooth contact will be visible when hand load is applied.
3. Tighten bearing cap bolts to 75 N·m (55 lbs. ft.).
4. Expand brake shoes until a torque of 54 to 70 N·m (40 to 50 lbs. ft.) is required to turn the pinion.

A test made without loading the gears will not give a satisfactory pattern. Turn pinion flange with wrench so that ring gear rotates one full revolution, then reverse rotation so that ring gear rotates one revolution in opposite direction.

5. Observe pattern on ring gear teeth and compare with chart.

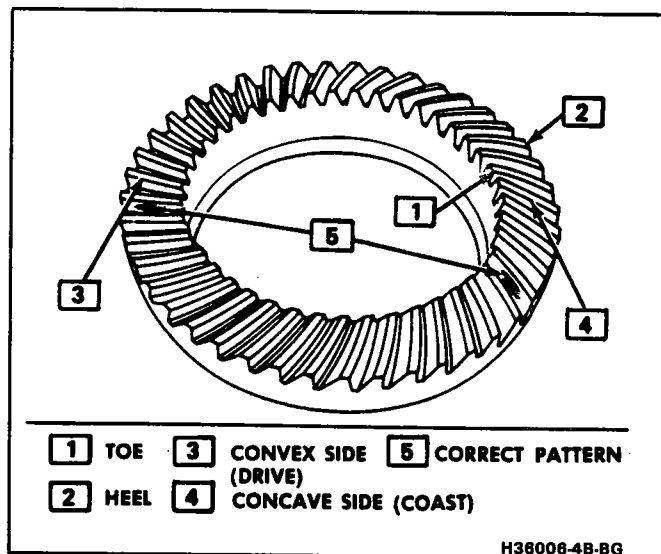

Figure 5 Desired Tooth Contact Under Light Load and Gear Tooth Nomenclature

Effects of Increasing Load on Tooth Contact Pattern

When "load" on ring and pinion gear is increased, such as when car is accelerated forward from standstill or from normal drive, the tooth contact will tend to spread out and, under very heavy load, will extend from near toe to near heel on the drive side. The entire contact also tends to shift toward heel under increasingly heavier loads and will become somewhat broader with respect to tops and bottoms of teeth. The patterns obtained by this tooth contact pattern test approximate a light load and, for this reason, they will extend only about halfway.

The important thing to note is that the contact pattern is centrally located up and down on the face of the ring gear teeth.

Adjustments Affecting Tooth Contact

See Figure 6

Two adjustments can be made which will affect tooth contact pattern, backlash and position of drive pinion in carrier. The effects of bearing preloads are not readily apparent on hand-loaded tooth contact pattern tests; however, these adjustments should be within specifications before proceeding with backlash and drive pinion adjustments.

Backlash is adjusted by means of the side bearing adjusting shims which moves the entire case and ring gear assembly closer to, or farther from, the drive pinion. The adjusting shims are also used to set side bearing preload. The position of the drive pinion is adjusted by increasing or decreasing the shim thickness between the pinion head and inner race of rear bearing. The shim is used in the rear axle to compensate for manufacturing tolerances.

Effects of Pinion Position on Tooth Pattern

See Figure 6

When the drive pinion is too far away from centerline of the ring gear, the pattern will be a high heel contact on the drive side and high toe contact on coast side. Moving the pinion closer to centerline of the ring gear by decreasing backlash will cause the high heel contact on drive side to lower and move toward

the toe; the high toe contact on coast side will lower and move toward the heel.

When the pinion is too close to the centerline of the ring gear, the pattern will be a low toe contact on drive side, and a low heel contact on the coast side. Moving the pinion farther away from the ring gear by increasing backlash will cause low toe contact on drive side to raise and move toward the heel; the low heel contact on coast side will raise and move toward the toe.

ON-CAR SERVICE

REAR AXLE FLUSHING PROCEDURE LIMITED SLIP DISC TYPE

In some cases after extended expressway driving during high ambient temperatures, a "slip/stick" condition may occur in the clutch plates of limited slip axles during tight turns. This condition may be described as "chatter". A rubbing or moaning noise may accompany this chatter.

This condition may be eliminated by flushing the rear axle using the following procedure:

1. Remove rear axle cover bolt and pry cover loose to drain lubricant, remove cover and gasket while lubricant is at operating temperature.
2. Reinstall cover and gasket and refill with rear axle lubricant 1052271 or equivalent.
3. Raise both rear wheels off the floor and with car properly supported, start engine and place transmission selector in "Drive". Run for four minutes at a speed not to exceed 30 mph on speedometer.
4. Loosen rear axle cover bolts and pry cover loose to drain lubricant.
5. Retighten cover bolts in a crosswise pattern. Tighten to 30 N·m (22 lbs. ft.).
6. Add rear axle lubricant additive 1052358 or equivalent to rear axle and then fill to a level flush with or within 6 mm (1/4 in.) of filler plug with rear axle lubricant 1052271 or equivalent.
7. Drive car in a figure eight manner, making at least ten (10) complete loops, to thoroughly work lubricant into the clutch pack. If this is not possible, the owner should be advised that it will require a minimum of 25 miles of normal driving to thoroughly work new lubricant into the clutch pack. If chatter recurs at a later mileage, add additive only.

CARRIER COVER GASKET

Remove or Disconnect

1. Raise car, see Section 0A.
2. Cover bolts and pry cover loose to drain lubricant.

Clean

- All dirt from area of carrier cover before removing cover.
- Both gasket sealing surfaces

Install or Connect

1. Cover bolts in a crosswise pattern and tighten to 30 N·m (22 lbs. ft.).
2. Fill with lubricant to a level flush with or within 6 mm (1/4 in.) of filler plug hole. Use rear axle lubricant 1052271 or equivalent. When refilling a limited slip axle, use additive 1052358 and rear axle lubricant 1052271.

AXLE SHAFT

See Figure 7

Remove or Disconnect

1. Raise car, see Section 0A.
2. Wheel and brake drum.

Clean

- All dirt from area of carrier cover.
3. Lubricant from carrier by removing cover.
 4. Rear axle pinion shaft lock bolt and the rear axle pinion shaft.
 5. "C" lock from button end of shaft by pushing flanged end of axle shaft into axle housing.
 6. Axle shaft from housing, being careful not to damage oil seal.

Install or Connect

1. Axle shaft into place taking care that splines on end of shaft do not damage oil seal and that they engage with splines of rear axle side gear.
2. Axle shaft "C" lock on button end of axle shaft and push shaft outward so that shaft lock seats in counterbore of rear axle side gear.
3. Rear axle pinion shaft through case, thrust washers and pinions, aligning hole in shaft with lock bolt hole.
4. Lock bolt and tighten to 27 N·m (20 lbs. ft.)
5. Carrier cover, using a new gasket, and tighten bolts to 30 N·m (22 lbs. ft.).
6. Axle lubricant to a level flush with or within 6 mm (1/4 in.) of filler hole. Use rear axle lubricant 1052271 or equivalent. When refilling a limited slip rear axle, use additive 1052358 and rear axle lubricant 1052271 or equivalent.
7. Brake drum and wheel
8. Lower car.

Inspect

- Operation of axle

AXLE OIL SEAL AND/OR BEARING WITH AXLE SHAFT REMOVED

See Figures 8 through 11

Tools Required:

- J 2619 Slide Hammer Assembly
- J 2619-4 Slide Hammer Adapter
- J 22813-01 Bearing and Seal Remover
- J 23765 Axle Shaft Bearing Installer

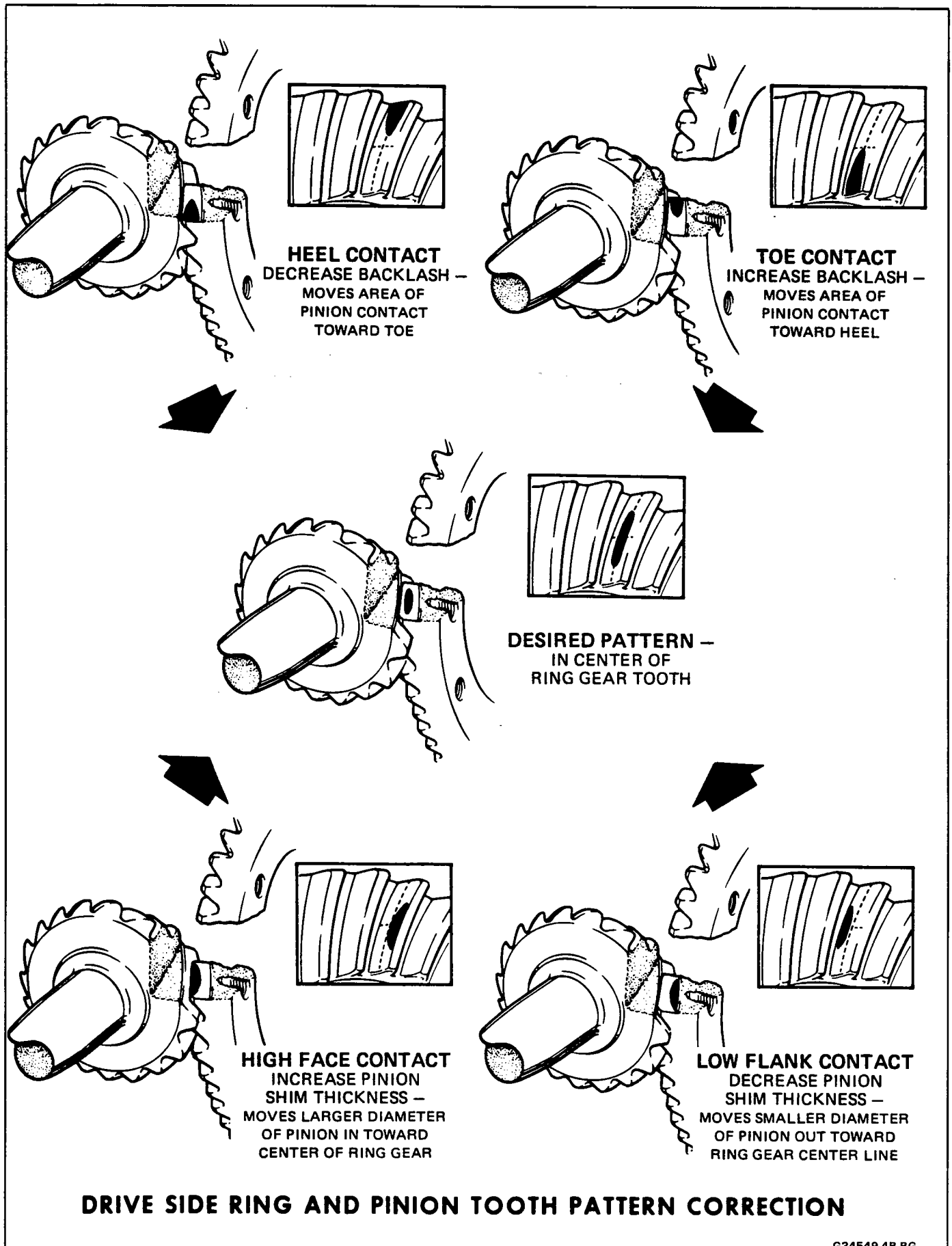

G34549-4B-BG

Figure 6 Gear Tooth Contact Pattern and Adjustments Affecting Tooth Contact.

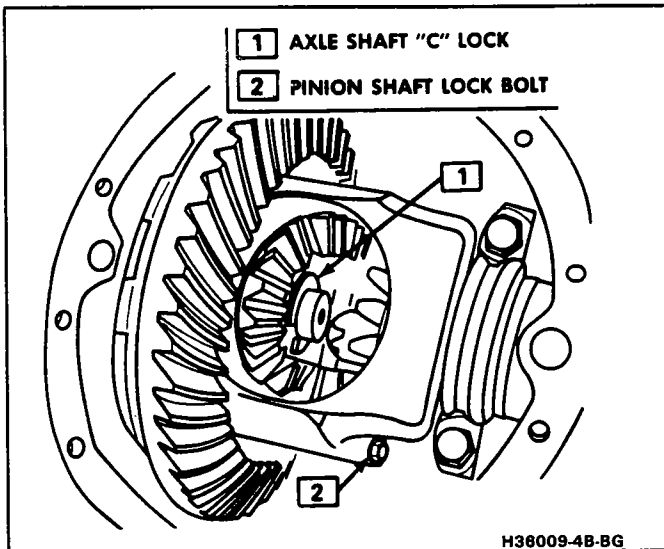

Figure 7 Pinion Shaft Lock Bolt

J 23771 Axle Shaft Seal Installer

↔ Remove or Disconnect

1. Seal from housing with a pry bar behind steel case of seal, being careful not to damage housing
2. Insert J 22813-01 into bore and position it behind bearing so that tangs on tool engage bearing outer race.
3. Bearing using slide hammer

↔ Install or Connect

1. Lubricate new bearing with gear lubricant.
2. Bearing so that tool bottoms against shoulder in housing, using J 23765.
3. Lubricate seal lips with gear lubricant.
4. Position seal on J 23771 and position seal into housing bore.
5. Seal into place, flush with axle tube

PINION YOKE OIL SEAL

See Figures 12 through 14

Tools Required:

- J 8614-02 Pinion Yoke Remover
- J 8614-03 Pinion Yoke Remover Screw
- J 8614-10 Pinion Yoke Holder
- J 23911 Pinion Oil Seal Installer 7 1/2 in. Axle
- J 22388 Pinion Oil Seal Installer 8 1/2 in. Axle

↔ Remove or Disconnect

1. Mark the propeller shaft and pinion yoke so they can be reassembled in the same position.
2. Propeller shaft from rear axle pinion yoke and support shaft up in body tunnel by wiring propeller shaft to the exhaust pipe.
3. If joint bearings are not retained by a retainer strap, use a piece of tape to hold bearings on their journals.

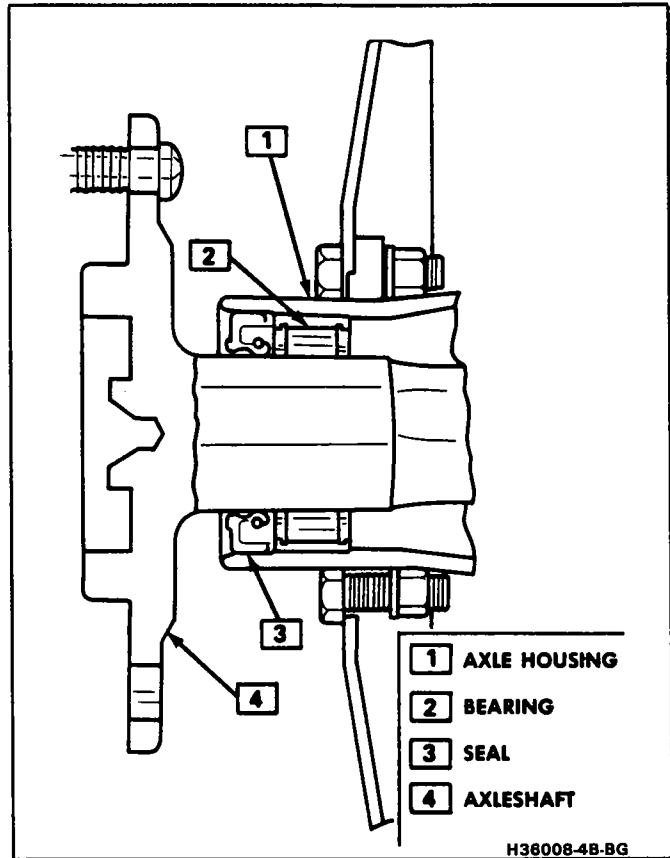

Figure 8 Axle Shaft Assembly

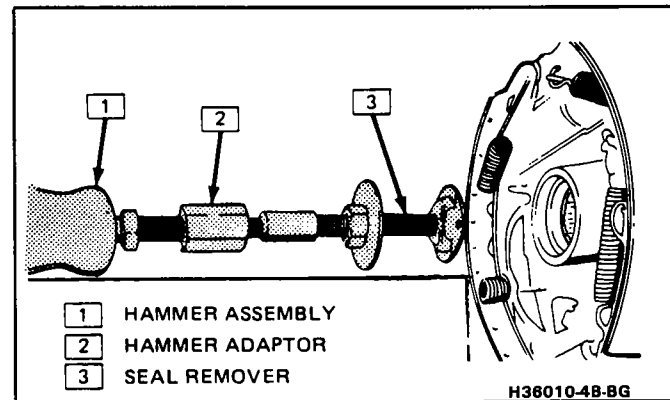

Figure 9 Removing Axle Bearing

4. Mark the position of the pinion yoke, pinion shaft and nut so the proper pinion bearing preload can be maintained.
5. Pinion yoke nut and washer
6. Use a suitable container to hold any fluid that may drain from rear axle.
7. Pinion yoke
8. Oil seal by driving it out of carrier with a blunt chisel. Do not damage carrier.

👁 Inspect

- Seal surface of pinion yoke for tool marks, nicks, or damage, such as a groove worn by the seal. If damaged, replace yoke as outlined under "Pinion Yoke".

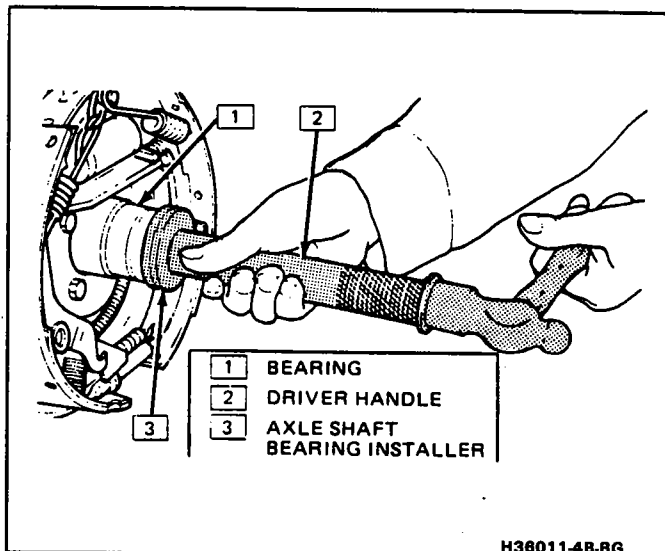

Figure 10 Installing Axle Bearing

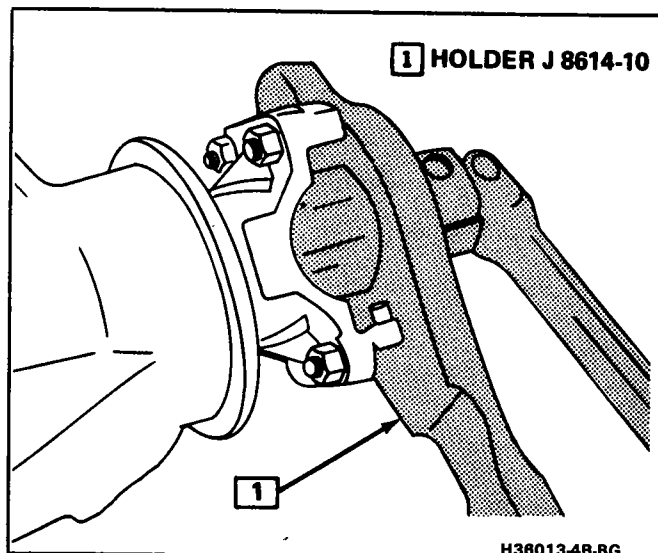

Figure 12 Removing Pinion Nut

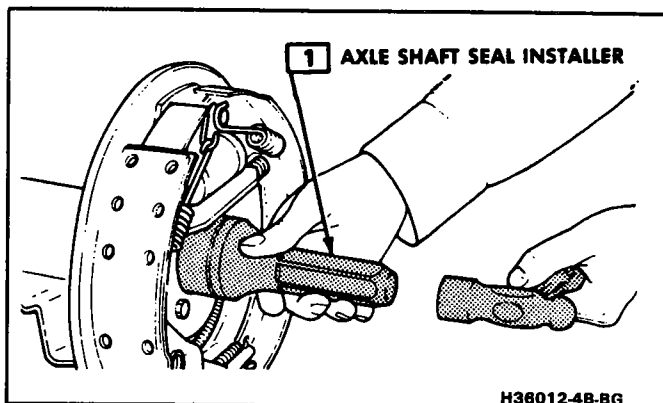

Figure 11 Installing Axle Seal

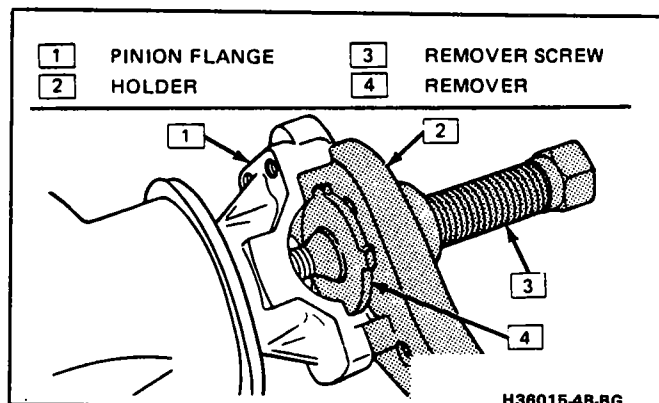

Figure 13 Removing Pinion Yoke

- Carrier bore and remove any burrs that might cause leaks around the O.D. of the seal.

↔ Install or Connect

- Oil seal using oil seal installer
- Seal lubricant, 1050169 or equivalent, to the O.D. of the pinion yoke and sealing lip of new seal.
- Pinion yoke and tighten nut to the same position as marked in Step 3. While holding pinion yoke, tighten nut 1.59 mm (1/16 in.) beyond alignment marks.

PINION YOKE

See Figures 12 through 15

Tools Required:

- J 8614-02 Pinion Yoke Remover
- J 8614-03 Pinion Yoke Remover Screw
- J 8614-10 Pinion Yoke Holder
- J 23911 Pinion Oil Seal Installer 7 1/2 in. Axle
- J 22388 Pinion Oil Seal Installer 8 1/2 in. Axle

↔ Remove or Disconnect

- Raise car, see Section 0A.

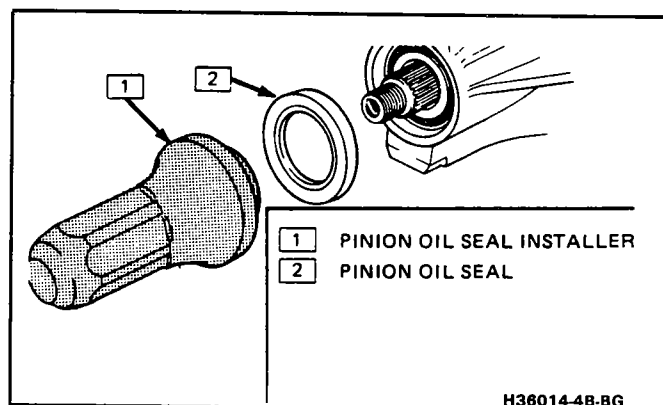

Figure 14 Installing Pinion Yoke Oil Seal

- Both rear wheels and drums
- Mark propeller shaft and pinion yoke relationship.
- Rear joint and support propeller shaft out of the way.
- If joint bearings are not retained by a retainer strap, use a piece of tape to hold bearings on their journals.
- Check preload with a pound inch torque wrench and record. This will give combined pinion bearing, carrier bearing, axle bearing and seal preload.

7. Pinion yoke nut and washer
8. Use with a suitable container to hold any fluid that may drain from the rear axle.
9. Pinion yoke
10. Oil seal by driving it out of carrier with a blunt chisel. Do not damage carrier.

↔ Install or Connect

1. Oil seal using oil seal installer
2. Apply special seal lubricant, 1050169 or equivalent, to the O.D. of the pinion yoke and sealing lip of new seal.
3. Pinion yoke
4. Washer and pinion yoke nut finger tight
5. While holding pinion yoke, tighten the nut gradually and turn drive pinion several revolutions after each tightening to set the bearings. Check the preload of bearings each time with a pound inch torque wrench until preload is 0.3 to 0.6 N·m (3 to 5 lbs. in.) more than reading obtained in Step 6 of the removal procedure.
6. Propeller shaft to rear axle pinion yoke. Refer to "Torque Specifications".
7. Drums and wheels
8. Axle lubricant to a level flush with or within 6 mm (1/4 in.) of filler hole. Use rear axle lubricant 1052271 or equivalent. When refilling a limited slip rear axle, use additive 1052358 and rear axle lubricant 1052271.
9. Lower car.

🔍 Inspect

- Operation of axle

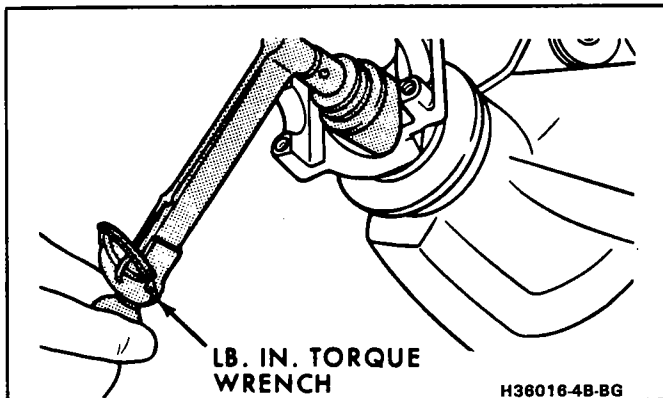

Figure 15 Checking Pinion Preload

REAR AXLE ASSEMBLY

It is not necessary to remove the rear axle assembly for any normal repairs. However, if the housing is damaged, the rear axle assembly may be removed and installed using the following procedure.

↔ Remove or Disconnect

1. Raise car, see Section 0A, and support car at frame. Hoist must remain under rear axle housing.
2. Shock absorbers from axle
3. Mark propeller shaft and pinion yoke

4. Propeller shaft and support out of the way
5. Brake line junction block bolt at axle housing
6. B Carline – brake lines at junction block. G Carline – brake lines at wheel cylinders
7. Upper control arms from axle housing
8. Lower rear axle assembly on hoist
9. Springs
10. Rear wheels and drums
11. Rear axle cover bolts and cover
12. Axle shaft. Refer to "Axle Shaft".
13. Brake lines from axle housing clips
14. Backing plates
15. Lower control arms from axle housing
16. Rear axle housing

↔ Install or Connect

1. Rear axle housing
2. Upper and lower control arms and tighten, refer to "Torque Specifications"
3. Backing plates
4. Position brake lines under axle housing clips. G Carline brake line to wheel cylinder.
5. Axle shaft. Refer to "Axle Shaft".
6. Rear axle cover and cover bolts to proper torque
7. Drums and wheels
8. Raise axle assembly on hoist.
9. Springs
10. Brake lines to junction block
11. Junction block bolt to axle housing
12. Propeller shaft. Tighten strap bolts to 21 N·m (16 lbs. ft.).
13. Shock absorbers to axle housing, refer to "Torque Specifications"
14. Axle lubricant to a level flush with or within 6 mm (1/4 in.) of filler hole. Use rear axle lubricant 1052271 or equivalent. When refilling a limited slip rear axle, use additive 1052358 and rear axle lubricant 1052271.
15. Bleed hydraulic brake system. See Section 5.
16. Remove jack stands and lower car.

UNIT REPAIR

Before attempting any service procedures the technician must know what type rear axle is to be serviced, refer to "Rear Axle Identification". to identify codes, ring gear size, and ratios. Also, refer to "Service Parts Identification" label on car, see Section 0A.

Most rear axle service repairs can be made by supporting the car by the frame with the axle housing supported and lowered to its lowest travel. On some carlines it may be necessary to disconnect shock absorbers to obtain additional clearance. When doing this, do not allow the rear brake hose to become kinked or stretched.

Lubricant may be drained by backing out all cover bolts and breaking cover loose at the bottom.

If the rear axle housing is removed for any reason, rear axle service can be performed on the bench.

When a new ring gear and pinion is installed, the owner should be advised not to accelerate rapidly or exceed 50 mph for the first 50 miles of driving.

 **Clean**

- All rear axle bearings thoroughly in clean solvent.

 **Inspect**

- Bearings visually and by feel. All bearings should feel smooth when oiled and rotated while applying as much hand pressure as possible. Minute scratches and pits that appear on rollers and races at low mileage are due to the initial preload, and bearings having these marks should not be replaced.
- Sealing surface of pinion flange for nicks, burrs, or rough tool marks which would cause damage to the seal and result in an oil leak. Replace if damaged.
- Carrier bore and remove any burrs that might cause leaks around the O.D. of the pinion yoke seal.
- Ring gear and drive pinion teeth for excessive wear and scoring. If any of these conditions exist, replacement of the gears as a set will be required.
- Pinion gear shaft for unusual wear; also check the pinion and side gears and thrust washers.
- Press fit of the side bearing inner race on the rear axle case hub by prying against the shoulder at the puller recess in the case. Side bearings must be a tight press fit on the hub.
- Diagnosis of a rear axle failure such as: chipped bearings, loose (lapped-in) bearings, chipped gears, etc., is a warning that some foreign material is present; therefore, the axle housing must be cleaned.

STANDARD REAR AXLE

REAR AXLE CASE REMOVAL WITH AXLE SHAFTS REMOVED

See Figures 16 and 17

 **Remove or Disconnect**

1. Before removing the rear axle case from the housing, ring gear to drive pinion backlash should be checked. This will indicate gear or bearing wear or an error in backlash or preload setting which will help in determining cause of axle noise.
2. Rear axle bearing cap bolts

 **Important**

- Bearing caps should be marked "R" and "L" to make sure they will be reassembled in their original location.
- Exercise caution in prying on carrier so that gasket sealing surface is not damaged.

- Place right and left bearing outer races and shims in sets with marked bearing caps so that they can be reinstalled in their original positions.

3. Rear axle case

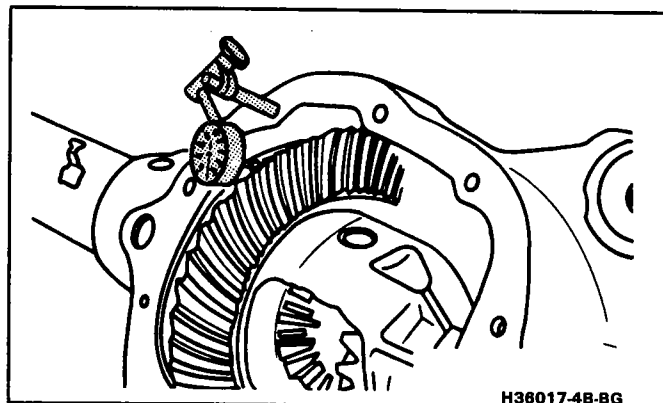

Figure 16 Checking Ring Gear to Pinion Backlash

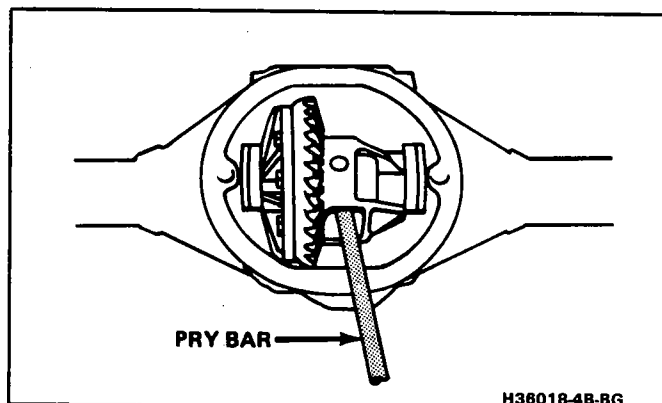

Figure 17 Removing Case Assembly

 **Disassemble**

See Figure 18

Tools Required:

- J 22888 Case Side Bearing Puller
- J 8107-2 Side Bearing Puller Adapter

1. Rear axle side bearings
2. Rear axle pinions, side gears and thrust washers from case. Mark side gears and case.
3. Ring gear bolts (L.H. threads)
4. Ring gear using a brass drift and hammer. Do not pry between ring gear and case.

 **Assemble**

See Figures 19 and 20

Before assembling the rear axle case, lubricate all parts with rear axle lubricant.

1. Side gear thrust washers over side gear hubs and install side gears in case. If same parts are reused, install in original sides.
2. Position one pinion (without washer) between side gears and rotate gears until pinion is directly

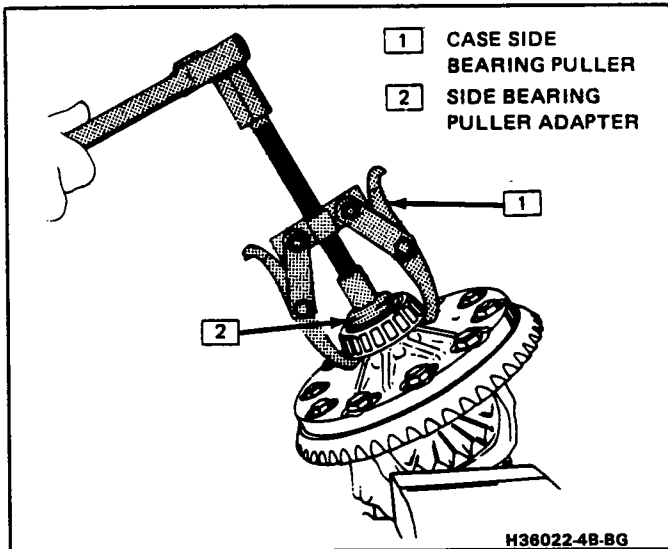

Figure 18 Removing Case Side Bearings

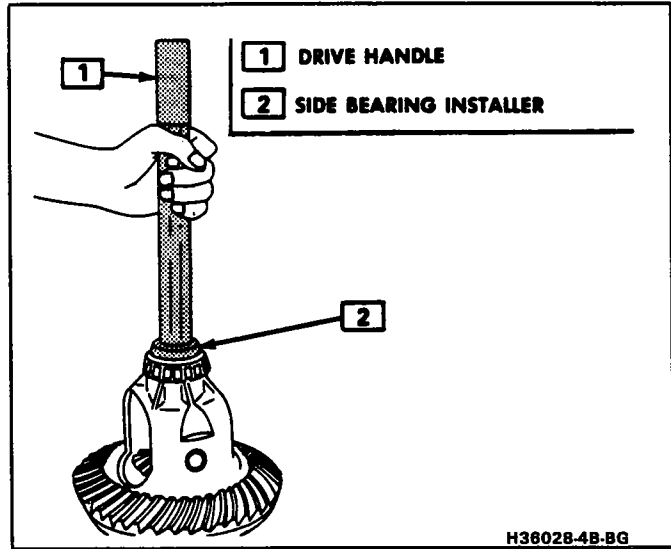

Figure 20 Installing Case Side Bearings

opposite from loading opening in case. Place other pinion between side gears so that pinion shaft holes are in line; then rotate gears to make sure holes in pinions will line up with holes in case.

3. If holes line up, rotate pinions back toward loading opening just enough to permit sliding in pinion thrust washers.
4. Ring gear on case using NEW ring gear attaching bolts with bolts just snug
 - NEVER REUSE OLD BOLTS.
 - Tighten bolts alternately in progressive stages to 120 N·m (90 lbs. ft.).
5. Case side bearings
6. Continue with "Side Bearing Shim Selection."

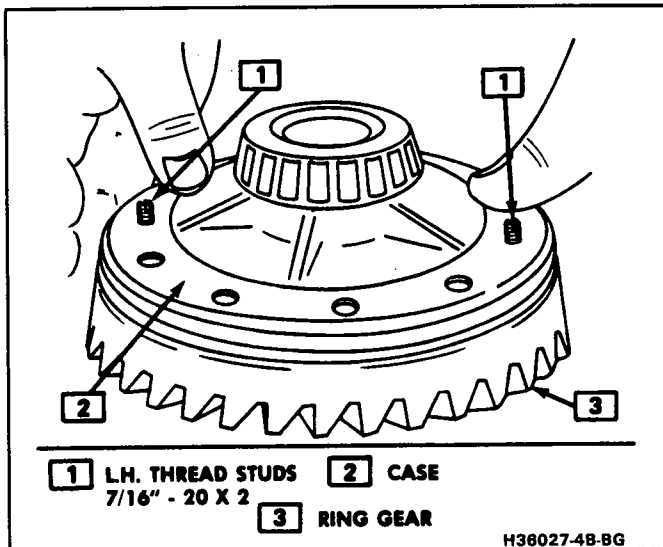

Figure 19 Installing Ring Gear on Case Assembly

Side Bearing Shim Selection

See Figure 21

Adjust

The side bearing preload adjustment is to be made before installing the pinion. If the pinion is installed, remove ring gear.

- Case side bearing preload is adjusted by changing the thickness of both the right and left shims by an equal amount.
- By changing the thickness of both shims equally, the original backlash will be maintained.
- Production shims are cast iron and vary in thickness from 5.33 mm to 6.91 mm (.210 in. to .272 in.) in increments of .05 mm (.002 in.)
- Standard service spacers are 4.32 mm (.170 in.) thick and steel service shims are available from 1.02 mm to 2.08 mm (.040 in. to .082 in.) in increments of .05 mm (.002 in.).

! Important

- Do not attempt to reinstall the production shims as they may break when tapped into place.
 - If service shims were previously installed, they can be reused, but whether using new or old bearings adhere to the following procedure in all cases.
1. Determine the approximate thickness of shims needed by measuring each production shim or each service spacer and shim pack.
 2. In addition to the service spacer, service shims will be needed. To select a starting point in service shim thickness, see the "Shim Thickness" chart.
 3. Place case with bearing outer races in position in carrier.
 4. Slip the service spacer between each bearing race and carrier housing with chamfered edge against housing.

Install the left bearing cap loose so that the case may be moved while checking

4.32mm (.170") SERVICE SPACER	
TOTAL THICKNESS OF BOTH PROD. SHIMS REMOVED	TOTAL THICKNESS OF SERVICE SHIMS TO BE USED AS A STARTING POINT
10.57mm .420"	1.52mm .060"
10.92mm .430"	1.78mm .070"
11.18mm .440"	2.03mm .080"
11.43mm .450"	2.29mm .090"
11.68mm .460"	2.54mm .100"
11.94mm .470"	2.79mm .110"
12.19mm .480"	3.05mm .120"
12.45mm .490"	3.30mm .130"
12.70mm .500"	3.56mm .140"
12.95mm .510"	3.81mm .150"
13.21mm .520"	4.06mm .160"
13.46mm .530"	4.32mm .170"
13.97mm .550"	4.83mm .190"

H36029-4B-BG

Figure 21 Shim Thickness

adjustments. Another bearing cap bolt can be added in the lower right bearing cap hole. This will prevent case from dropping while making shim adjustments.



Measure

- Select one or two shims totalling the amount shown in the right hand column and position between the right bearing race and the service spacer.
 - Be sure left bearing race and spacer are against left side of housing.
1. Insert progressively larger feeler gage sizes .25 mm, .30 mm, .36 mm, etc. (.010 in., .012 in., .014 in, etc.) between the right shim and service spacer until there is noticeable increase in drag.
 2. Push the feeler gage downward until the end of the gage makes contact with the carrier bore so as to obtain a correct reading.
 3. The point just before additional drag begins is correct feeler gage thickness.
 4. Rotate case while using feeler gage to assure an even reading.
 - The original light drag is caused by weight of the case against the carrier while additional drag is caused by side bearing preload.
 - By starting with a thin feeler gage, a sense of "feel" is obtained so that the beginning of preload can be recognized to obtain ZERO clearance.
 - It will be necessary to work case in and out and to the left in order to insert the feeler gage.
 5. Remove left bearing cap and shim from carrier.
 6. The total shim pack needed (with no preload on side bearings) is the feeler gage reading found in Step 1 plus thickness of shims installed in Step 3.
 7. Select two shims of approximately equal size whose total thickness is equal to the value obtained in Step 1.

- These shims will be installed between each side bearing race and service spacer when the case is installed in the carrier.
 - The preload will not be added until the final step.
8. If the pinion is in position, install the ring gear, then proceed to "Rear Axle Backlash."

Rear Axle Backlash

Tool Required:

J 8001 Dial Indicator Assembly



Adjust

1. Install rear axle case into carrier, using shims as determined by "Side Bearing Shim Selection".
2. Rotate rear axle case several times to seat bearings, then mount J 8001.
 - Use a small button on the indicator stem so that contact can be made near heel end of tooth.
 - Set Dial Indicator so that stem is in line with gear rotation and perpendicular to tooth angle for accurate backlash reading.
3. Check backlash at three or four points around ring gear.
 - Lash must not vary over .05 mm (.002 in.) around ring gear.
 - Pinion must be held stationary when checking backlash.



Important

- If variation is over .05 mm (.002 in.) check for burrs, uneven bolting conditions or distorted case flange and make corrections as necessary.
4. Backlash at the point of minimum lash should be between .13 mm and .23 mm (.005 in. and .009 in.) for all new gears.
 5. Backlash by increasing thickness of one shim and decreasing thickness of other shim the same amount.
 - For each .03 mm (.001 in.) change in backlash desired, transfer .05 mm (.002 in.) in shim thickness.
 - To decrease backlash .03 mm (.001 in.), decrease thickness of right shim .05 mm (.002 in.). To increase backlash .05 mm (.002 in.), and increase thickness of left shim .05 mm (.002 in.). To increase backlash .05 mm (.002 in.), increase thickness of right shim .10 mm (.004 in.) and decrease thickness of left shim .10 mm (.004 in.).
 6. Continue with "Side Bearing Preload and Case Installation."

Side Bearing Preload and Case Installation

See Figure 22

Tool Required:

J 25588 Side Bearing Shim Installer

**Adjust**

1. Keep shim packs in their respective position, right or left side.
2. Select a shim .10 mm (.004 in.) thicker than one removed from left side, then insert left side shim pack between the spacer and the left bearing race.
3. Loosely install bearing cap.
4. Select a shim .10 mm (.004 in.) thicker than the one removed from right side and insert between the spacer and the right bearing race.
5. It will be necessary to drive the right shim into position using J 25588.
6. Tighten side bearing caps to 75 N·m (55 lbs. ft.).
7. Recheck backlash and correct if necessary.
8. Install axles, see "Rear Axle."
9. Install new cover gasket.
10. Install cover and tighten cover bolts to 30 N·m (22 lbs. ft.).
11. Fill rear axle to a level flush with or within 6 mm (1/4 in.) of filler hole.

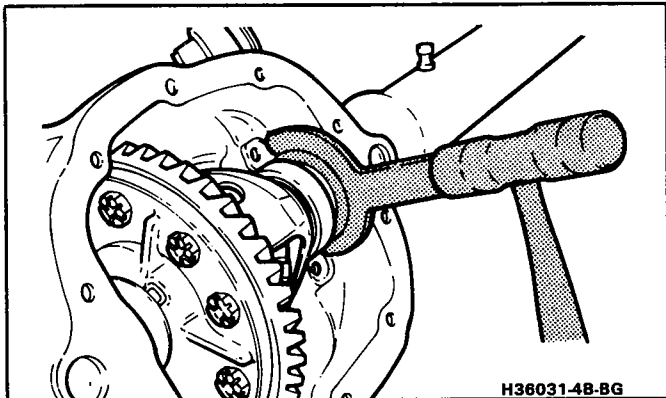

Figure 22 Installing Case Preload Adjusting Shims

DRIVE PINION, BEARINGS AND RACES WITH CASE REMOVED**Drive Pinion**

See Figure 23

Tools Required:

J 22536 Pinion Driver

**Remove or Disconnect**

1. Remove rear axle case, see "Rear Axle Case Removal."
2. Check drive pinion bearing preload. If there is no preload reading, check for looseness of pinion assembly by shaking. Looseness could be caused by defective bearings or worn pinion yoke. If rear axle was operated for an extended period with very loose bearings, the ring gear and drive pinion will also require replacement.
3. Pinion yoke, see "Pinion Yoke."
4. Install J 22536 and drive out pinion. Apply heavy hand pressure on pinion remover toward rear axle housing to keep front bearing seated to avoid damage to outer race.

**Install or Connect**

1. If installing a new ring and pinion, measure pinion depth before installing rear pinion bearing, see "Pinion Depth".
2. Rear pinion bearing outer race if necessary, see "Rear Pinion Bearing"
3. Front pinion bearing outer race if necessary, see "Front Pinion Bearing"
4. NEW collapsible spacer on pinion and position lubricated assembly in carrier.
5. Hold forward on pinion into carrier assembly.
6. Front bearing on pinion and drive bearing on pinion shaft until seated in race.

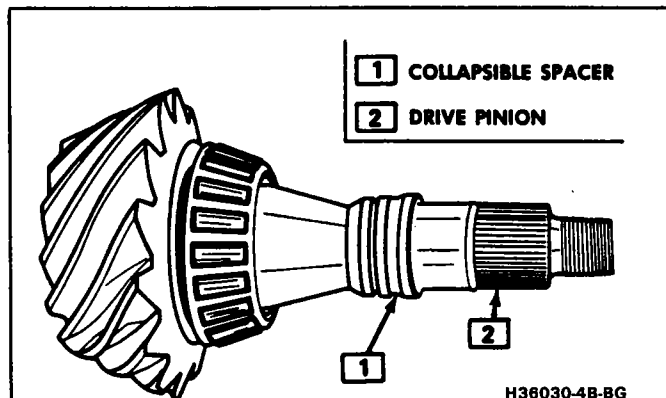

Figure 23 Collapsible Spacer on Drive Pinion

7. Pinion yoke seal in carrier, see "Pinion Yoke Oil Seal."
8. Coat lips of pinion oil seal and seal surface of pinion yoke with Lubricant, No. 1050169 or equivalent.
9. Pinion yoke on pinion by tapping with a soft hammer until a few pinion threads project through yoke.
10. Install pinion yoke washer and nut.
 - Hold pinion yoke.
 - While intermittently rotating pinion to seat pinion bearings, tighten pinion yoke nut until end play begins to be taken up.

**Important**

- When no further end play is detectable and when holder will no longer pivot freely as pinion is rotated, preload specifications are being approached.
 - No further tightening should be attempted until the preload has been checked.
11. Check preload by using a torque wrench.
 - After preload has been checked, final tightening should be done very carefully.
 - Additional tightening of the pinion yoke nut can add many additional pounds inch of torque.
 - The pinion yoke nut should be further tightened only slightly and the preload should be checked after each tightening.

- Exceeding preload specifications will compress the collapsible spacer too far and require the installation of a new collapsible spacer.
12. Set preload at 2.26 to 2.82 N·m (20 to 25 lbs. in.) on new bearings or 1.13 to 1.69 N·m (10 to 15 lbs. in.) on used bearings.
 13. Rotate pinion several times to assure that bearings have been seated.
 - Check preload again.
 - If preload has been reduced by rotating pinion, reset preload to specifications.
 14. Continue with rear axle case service, see "Rear Axle Case Removal."

Rear Pinion Bearing

See Figures 24 through 26

Tools Required:

- J 22912-01 Rear Pinion Bearing Remover 7 1/2 in. Axle
- J 8612-01 Rear Pinion Bearing Remover 8 1/2 in. Axle
- J 8092 Drive Handle
- J 6197 Rear Pinion Bearing Outer Race Installer 7 1/2 in. Axle
- J 8608 Rear Pinion Bearing Outer Race Installer 8 1/2 in. Axle

↔ Remove or Disconnect

1. Drive pinion, see "Drive Pinion, Bearings and Races"
2. Bearing from the pinion gear
3. If bearing is being replaced, remove outer race from carrier using a punch in slots provided for this purpose.

→← Install or Connect

1. Rear pinion bearing outer race
2. Rear pinion bearing on pinion using correct shim (if used)
3. Drive pinion, see "Drive Pinion, Bearings and Races"

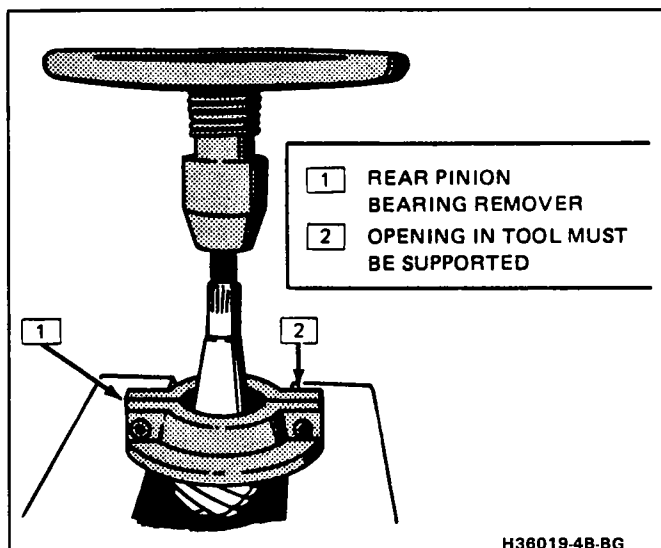

Figure 24 Removing Rear Pinion Bearing

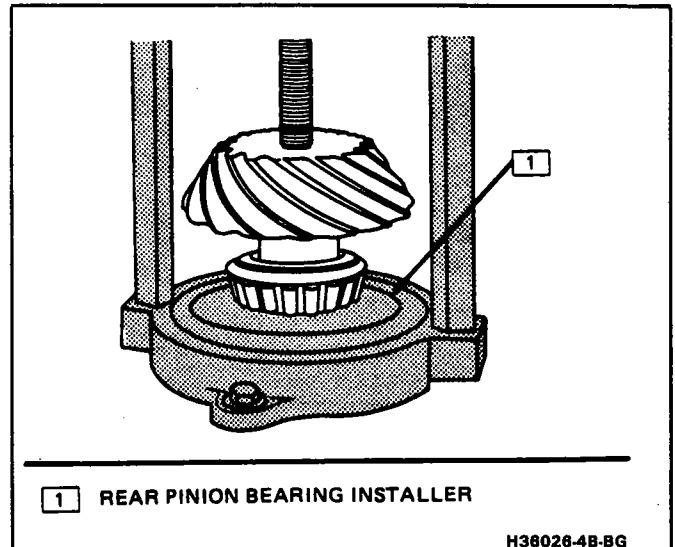

Figure 25 Installing Rear Pinion Bearing

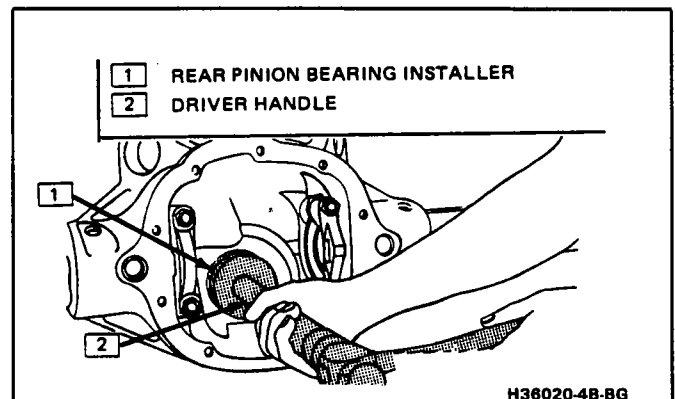

Figure 26 Installing Rear Pinion Bearing Outer Race

Front Pinion Bearing

See Figure 27

Tools Required:

- J 8092 Drive Handle
- J 7817 Front Pinion Bearing Outer Race Installer 7 1/2 in. Axle
- J 8611-01 Front Pinion Bearing Outer Race Installer 8 1/2 in. Axle

↔ Remove or Disconnect

1. Drive pinion, see "Drive Pinion, Bearings and Races"
2. Remove outer race from carrier using a punch in slots provided for this purpose.

→← Install or Connect

1. Front pinion bearing outer race
2. Drive pinion, see "Drive Pinion, Bearings and Races"

PINION DEPTH

See Figures 28 through 30

Tools Required:

- J 21777 Pinion Setting Gage

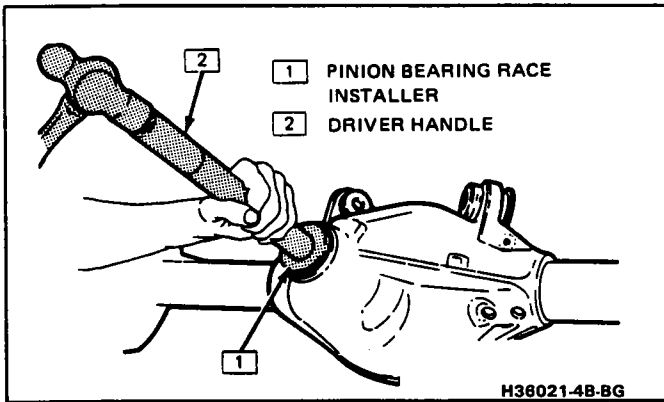

Figure 27 Installing Front Pinion Bearing Outer Race

Measure

Pinion depth is measured with J 21777. The pinion setting gage provides a "nominal" or "zero" pinion as a gaging reference.

1. Make certain all of the gage parts are clean.
2. Lubricate front and rear pinion bearings liberally with rear axle lubricant.
3. While holding pinion bearings in position, install J 21777.
4. Hold stud stationary with a wrench positioned over the flats on the ends of stud and tighten nut to 2.2 N·m (20 lbs. in.) of torque. Rotate Gage Plate assembly several complete revolutions to seat the bearings. Tighten nut until a torque between 1.6 and 2.2 N·m (15 and 25 lbs. in.) is obtained to keep the Gage Plate rotating.

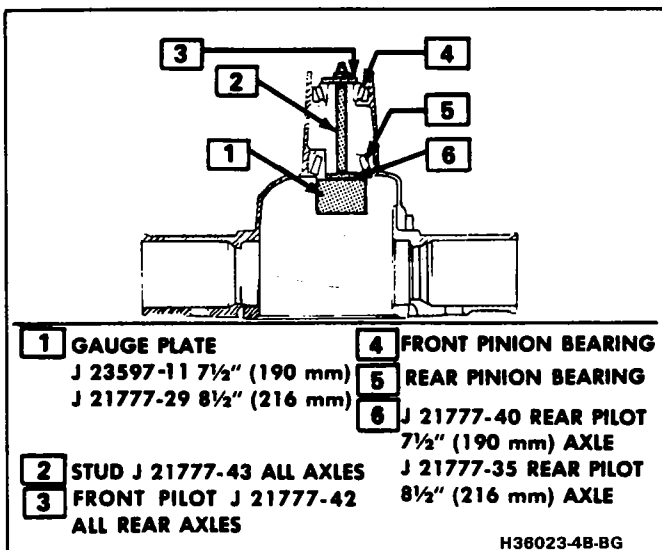

Figure 28 Pinion Gage Plate Installed in Carrier

5. Rotate the Gage Plate until the gaging areas are parallel with the Discs as shown. Use the high step on J 23597-11 with Discs J 21777-45 on 7-1/2 in. ring gears. The gaging area marked "A" on Gage Plate J 21777-21 is used with Discs J 21777-45 and J 21777-1 on 8 1/2 in. ring gears.
6. Install the correct Discs on the Gage Shaft.
7. Position the Gage Shaft assembly in the carrier so that the Dial Indicator rod is centered on the gaging area of the Gage Block, and the Discs

seated fully in the side bearing bores. Install side bearing caps and tighten bolts to 75 N·m (55 lbs. ft.). Use Dial Indicator J 8001 or an equivalent indicator reading from 0 mm to 2.5 mm (0 in. to .100 in.).

8. Set Dial Indicator at ZERO. Then position on mounting post of the Gage Shaft with the contact button touching the indicator pad. Push Dial Indicator downward until the needle rotates approximately 3/4 turn clockwise. Tighten the Dial Indicator in this position and recheck.
9. Rotate Gage Shaft slowly back and forth until the Dial Indicator reads the greatest deflection. At the point of greatest deflection, set the Dial Indicator to ZERO. Repeat rocking action of Gage Shaft to verify the ZERO setting.
10. After the ZERO setting is obtained, rotate Gage Shaft until the Dial Indicator rod does not touch the Gage Block.
11. Record dial reading at pointer position. Example: If pointer moved counterclockwise 1.70 mm (.067 in.) to a dial reading of .84 mm (.033 in.) as shown, this indicates a shim thickness of .84 mm (.033 in.) except as follows:
Dial Indicator reading should be within the range of .50 mm to 1.27 mm (.020 in. to .050 in.).
12. On type "K" axle assemblies, select the correct drive pinion shim to be used during drive pinion reassembly on the following basis:
 - a. If a drive pinion with no marking is being used, the correct shim will have a thickness EQUAL to the indicator gage reading found in Step 12.
 - b. Drive pinions that are marked, "+" (plus), the shim thickness indicated by the Dial Indicator on the Pinion Setting Gage must be INCREASED by the amount on the drive pinion.
 - c. If the drive pinion is marked "-" (minus), the shim thickness indicated by the Dial Indicator on the Pinion Setting Gage must be DECREASED by the amount on the drive pinion.
 - Shims are available in .03 mm to .94 mm (.001 in. to .037 in.).
 - Each shim has the thickness etched on flat surface for easy identification.
 - On type "C" and "G" axle assemblies, drive pinions will not have any markings, they are nominal gears.
13. Loosen Stud J 21777-43 and remove Gage Plate, washer and both bearings from carrier.
14. Position correct shim on drive pinion and install the drive pinion rear bearing.

LIMITED SLIP REAR AXLE

REAR AXLE CASE DISC TYPE

See Figures 31 through 33

CAUTION: To avoid possible injury, never raise one wheel and run the engine with the transmission in gear.

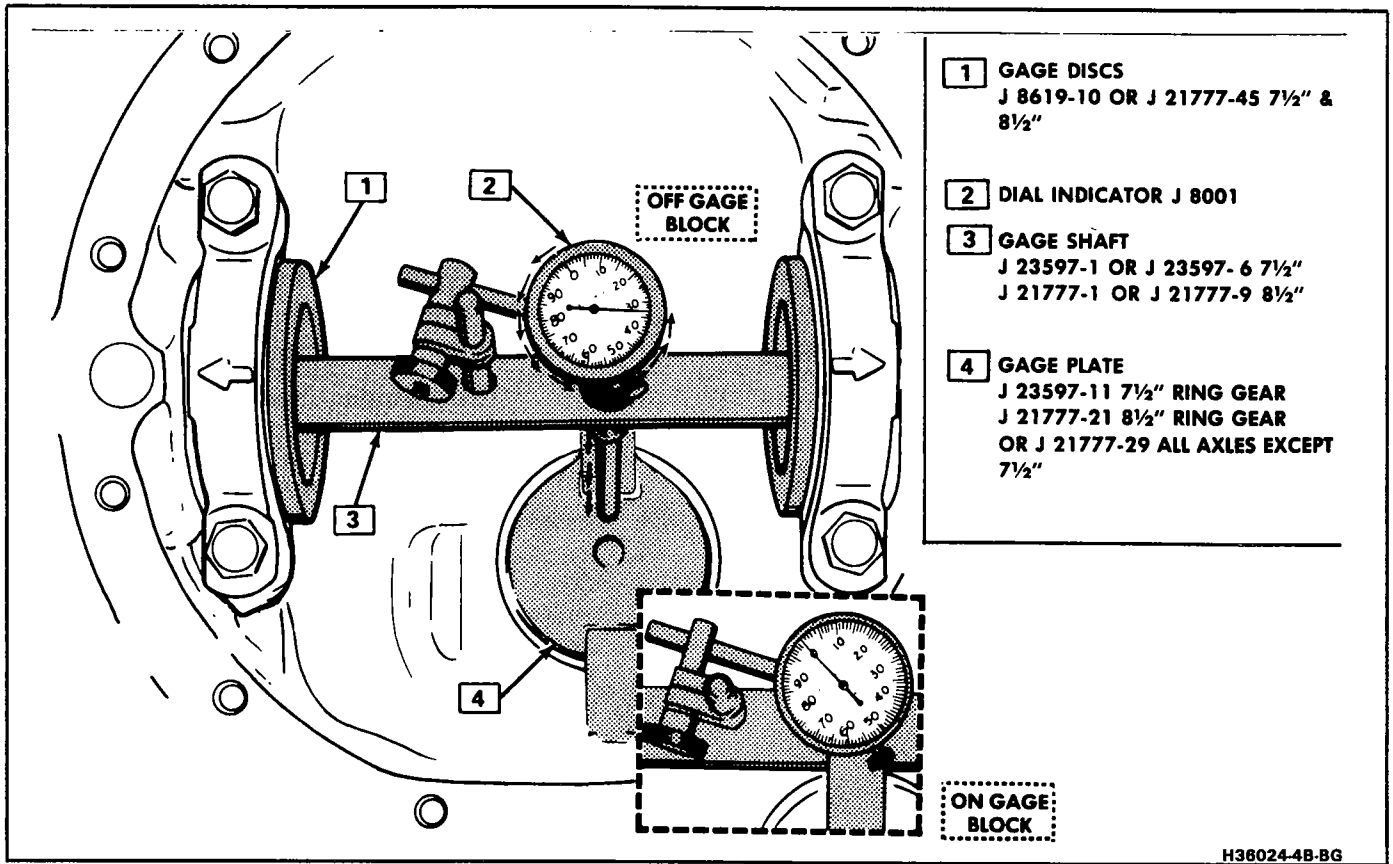

Figure 29 Checking Pinion Depth

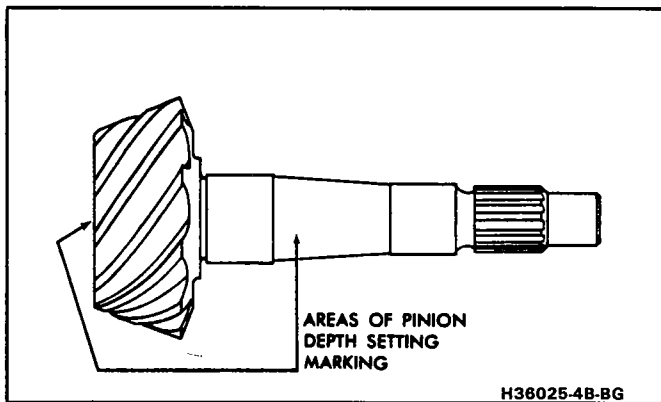

Figure 30 Pinion Marking

The driving force to the wheel on the floor will cause the car to move. Do not use "on the car" type wheel balancers on the rear wheels unless both wheels are off the floor.

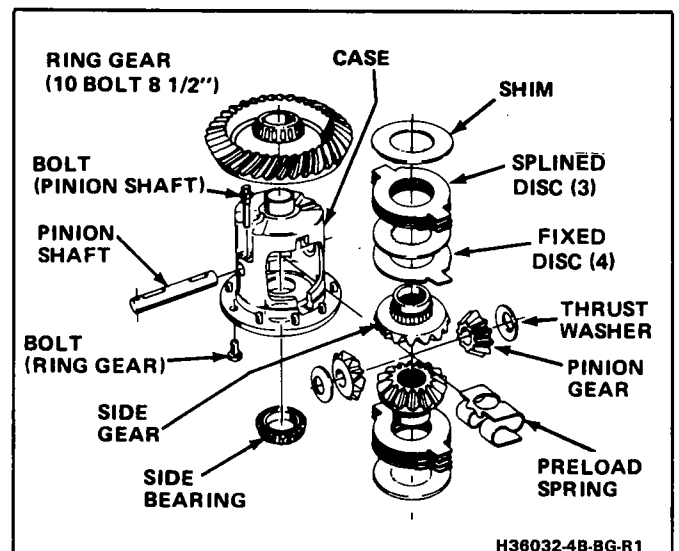

Figure 31 Limited Slip Rear Axle - Disc Type

Disassemble

1. Side bearings as outlined in the "Standard Rear Axle" section under "Rear Axle Case Removal."
2. Ring gear from case (L.H. threads)
3. Pinion shaft lock bolt and then pinion shaft from case
4. Drive the preload spring from the case
5. Rotate side gears until the pinions are in the open area of the case. Remove the pinion gears and thrust washers.

6. Side gear, clutch pack and shims from the case, noting its location in the case to aid in reassembly.
7. Opposite side gear clutch pack and shims from the opposite side.
8. Shims and clutch plates from the side gears. Keep the clutch plates in their original location in the clutch pack.

Assemble

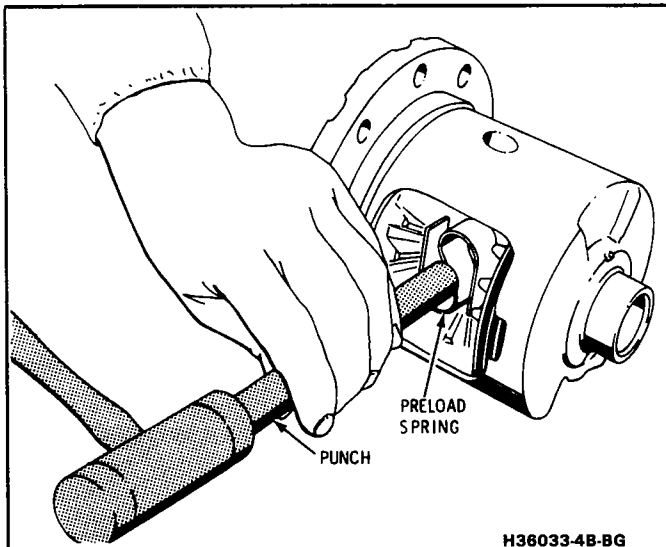

Figure 32 Removing Preload Spring

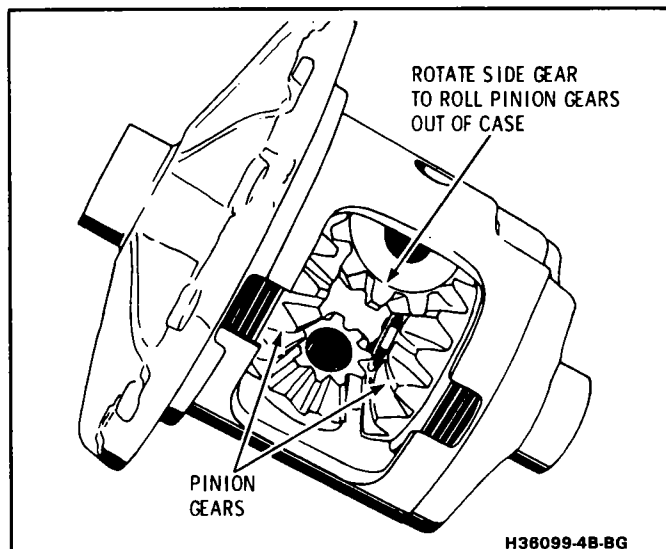

Figure 33 Removing and Installing Pinions or Washers

See Figures 33 through 35

Tool Required:

J 8001 Dial Indicator Assembly

1. Side bearings on case hubs after lubricating with lubricant No. 1052271 or equivalent.
2. Apply lubricant No. 1052271 or equivalent to the clutch plates.
3. Assemble the clutch pack as follows:
 - Alternately position clutch plates on the side gear, **STARTING** and **ENDING** with a clutch plate having external lugs.
 - Repeat the same for opposite side.
4. Check the pinion to the side gear clearance as follows:
 - Install one side gear with clutch pack and original shims in the case.
 - Position the two pinion gears and thrust washers on the side gear and install the pinion shaft.
 - Compress the clutch pack by inserting a screwdriver or wedge between the side gear and pinion shaft.

- Install Dial Indicator J 8001 with the contact button against the pinion gear.
 - Rotate pinion gear. Clearance should be .03 mm to .15 mm (.001 in. to .006 in.).
 - If clearance is more than .15 mm (.006 in.), add shims between clutch pack and case.
 - If clearance is less than .03 mm (.001 in.) remove shims.
 - A .05 mm (.002 in.) shim will change clearance approximately .03 mm (.001 in.).
 - Recheck clearance after adding or subtracting shims.
 - Remove side gear and repeat procedure with opposite clutch pack, on opposite side of case.
5. Remove pinion shaft, pinions and thrust washers.
 6. Remaining side gear and clutch pack with correct shims in the case.
 7. Pinion gears on the side gears and rotate into correct position.
 8. Thrust washers behind the pinion gears and align.
 9. Pinion shaft into the case, through the thrust washer and part way into the pinion gear.
 10. Preload spring next to the side gears and drive into place
 11. Pinion shaft into position and align the lock screw hole in the shaft with the hole in the case.
 12. Install the pinion shaft lock bolt and tighten to 27 N·m (20 lbs. ft.).
 13. Ring gear on the case flange and install **NEW** attaching bolts. Tighten the attaching bolts evenly and alternately across the diameter in progressive stages.
 - Tighten to 120 N·m (90 lbs. ft.).
 14. Side bearings
 15. Install case, see “Side Bearing Shim Selection.”

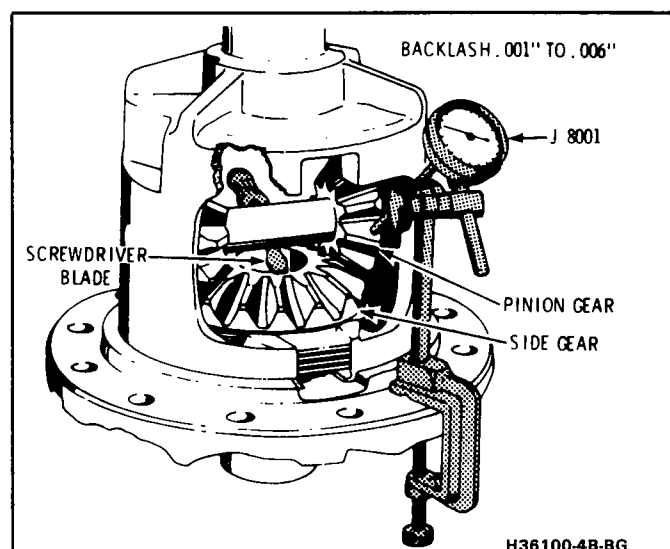

Figure 34 Check Side Gear to Pinion Backlash

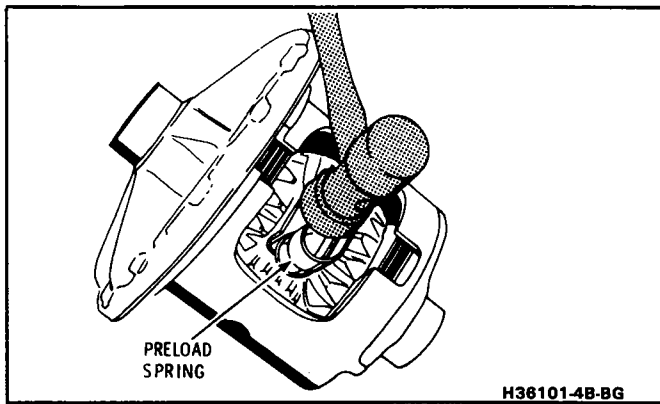

Figure 35 Install Preload Spring

CONE TYPE

See Figure 36

CAUTION: To avoid possible injury, never raise one wheel and run the engine with the transmission in gear. The driving force to the wheel on the floor will cause the car to move. Do not use "on the car" type wheel balancers on the rear wheels unless both wheels are off the floor.

Disassemble

1. Side bearings as outlined in the "Standard Rear Axle" section under "Rear Axle Case Removal."

Inspect

- Rear axle case side bearings for visible damage of rollers and outer races.
 - Place one outer race onto its matched inner race and roller assembly and turn slowly, applying hand load.
 - If bearing outer race turns smoothly and no visible damage is found, bearing can be reused.
 - Repeat above operation with other race and matched bearing and check for smoothness.
 - Fit of inner races on case hubs by prying against shoulders at puller recesses.
 - Bearing inner races must be tight on case hubs.
 - If either bearing is loose on case, entire case must be replaced.
2. Rear axle case half attaching bolts

3. Alternately loosen each bolt a small amount until pressure is released.
4. Cap half of case from flange half, clutch cone/side gears, spring blocks, preload springs, pinion gears and shaft

Inspect

- Make certain all parts are absolutely clean and dry.
- Pinion shaft, pinion and side gears, brake cone surfaces and corresponding cone seats in case.
 - The cone seats in case should be smooth and free of any excessive scoring.
 - Slight grooves or scratches, indicating passage of foreign material, are permissible and normal.
 - The land surface on the heavy spirals of male cones will duplicate case surface condition.
 - If case or clutch cone/side gear are damaged, it is necessary to replace case assembly.

Assemble

See Figures 37 through 41

1. Cone/gear assembly, seating it into position in cap half of case.

Important

- Since tapers and surfaces become matched, their positions should not be changed.
2. Spring block in position over gear face, in alignment with pinion gear shaft grooves.
 - Install pinion shaft, pinion gears and thrust washers (in original locations) into cap half of rear axle case in such a manner that pinion shaft retaining dowel can be inserted through pinion gear shaft into rear axle case. This prevents pinion shaft from sliding out and causing damage to carrier.
 3. Five springs into spring block that is already installed into case, then place second spring block over springs.
 4. Second cone/gear assembly face down on spring block so that gear will mesh with pinion gears.
 5. Flange half of rear axle case over cone, insert case bolts finger tight
 6. Tighten bolts one turn at a time in the sequence shown to a final torque of 40 N·m (30 lbs. ft.).
 7. Side bearings
 8. Install case, see "Side Bearing Shim Selection."

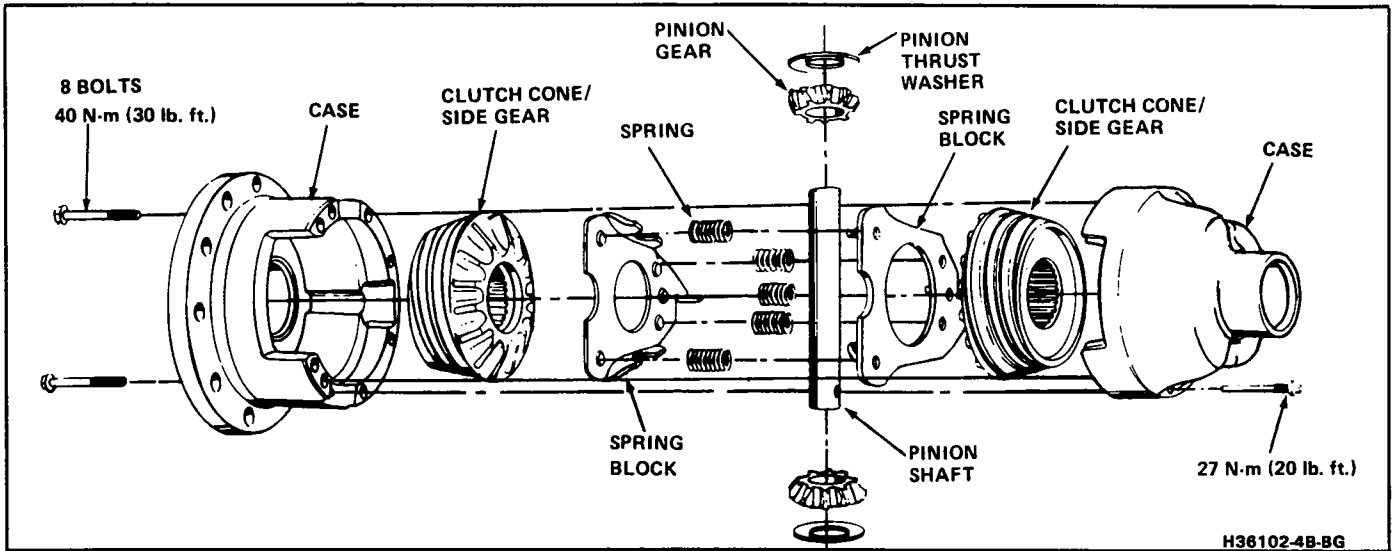

Figure 36 Limited Slip Rear Axle - Cone Type

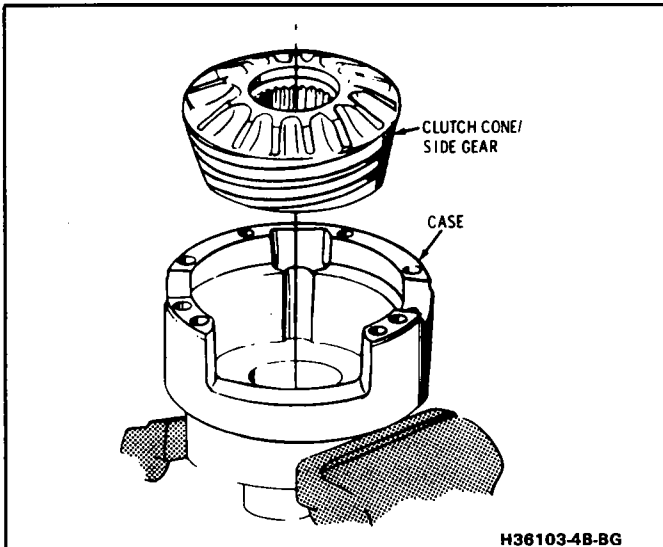

Figure 37 Install Clutch Cone/Side Gear

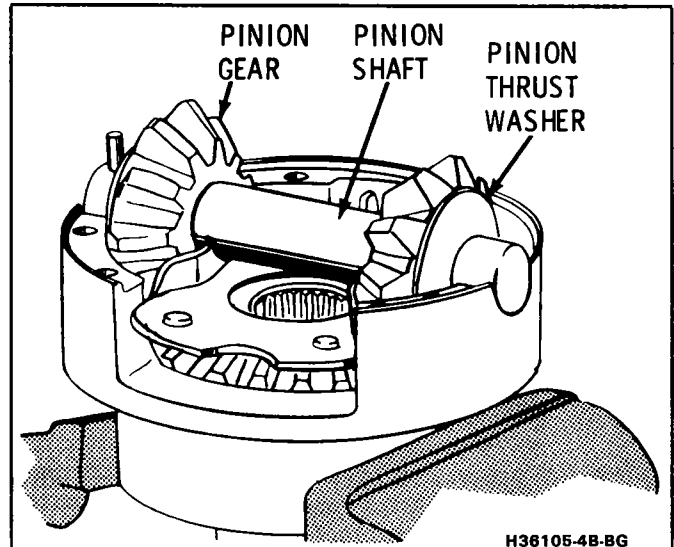

Figure 38 Install Parts In Case Half

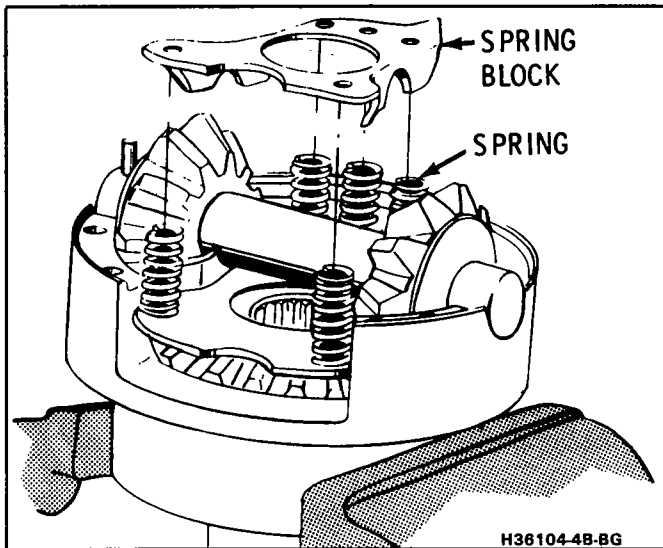

Figure 39 Install Spring Block

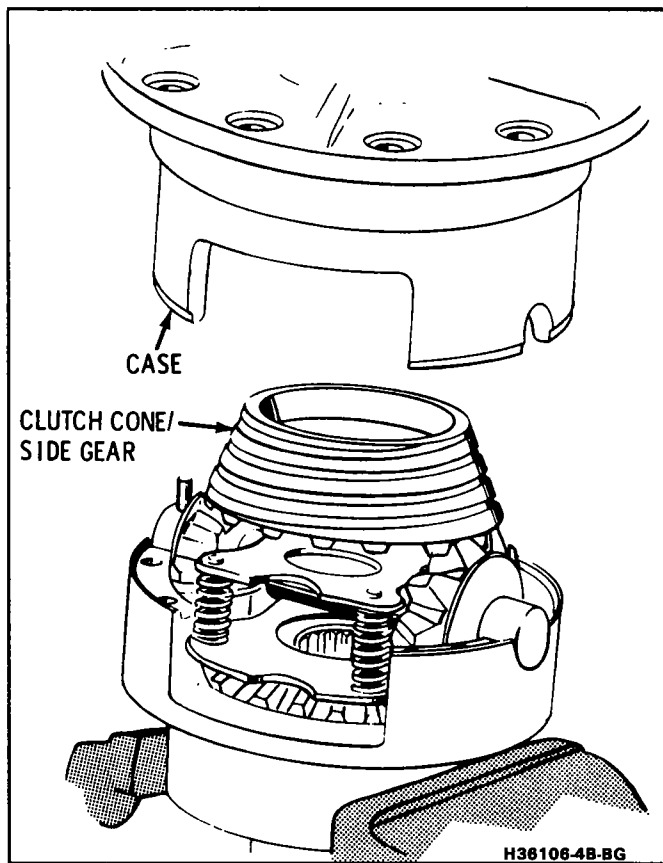

Figure 40 Install Flange Half of Case

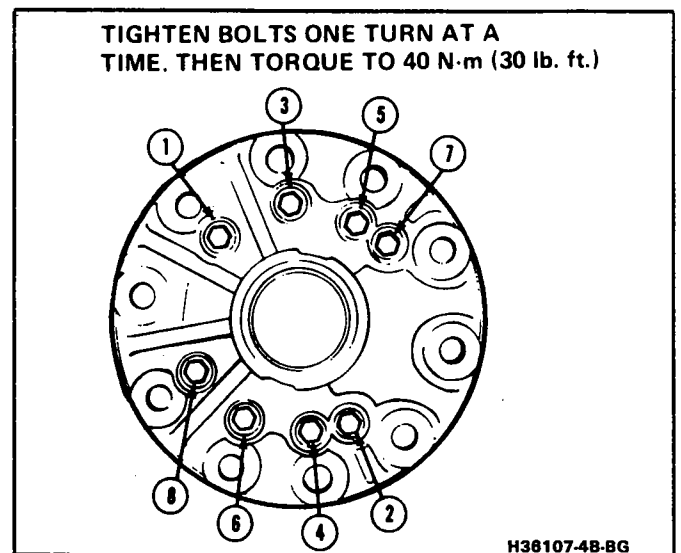

Figure 41 Torque Case Bolts

REAR AXLE SPECIFICATIONS

TORQUE SPECIFICATIONS

Use a reliable torque wrench to tighten the parts listed to insure proper tightening without straining or distorting parts. These specifications are for clean and lightly-lubricated threads only; dry or dirty threads produce increased friction which prevents accurate measurement of tightness.

APPLICATION	N·m – LBS. FT.	
Rear Universal Joint to Pinion Yoke (Strap or U-Bolt)	20	(15)
Rear Axle Housing Cover to Carrier	30	(22)
Brake Assembly to Rear Axle Housing		
G Carline	48	(35)
B Carline	48	(35)
Ring, Gear to Differential Case (L.H. Thread)	120	(89)
Bearing Cap to Carrier	75	(55)
Rear Wheel to Axle Shaft		
G Carline	108	(80)
B Carline	135	(100)
Upper and Lower Control Arm		
G Carline – Bolt	110	(80)
G Carline – Nut	95	(70)
Upper Control Arm at Frame		
B Carline	125	(95)
Upper Control Arm at Axle		
B Carline – Nut	95	(70)
B Carline – Bolt	110	(80)
Lower Control Arm at Axle		
B Carline – Nut	125	(95)
B Carline – Bolt	165	(120)
Lower Control Arm at Frame		
B Carline – Bolt	165	(120)
B Carline – Nut	125	(95)
Lower End of Shock Absorber	88	(65)
Pinion Nose Bumper		
B Carline	20	(15)
Filler Plug	41	(30)

GENERAL SPECIFICATIONS

Rear Axle Type	Semi-Floating Hypoid
Drive and Torque	Through 4 Arms
Rear Axle Oil Capacity – 8 1/2 in. Ring Gear Axle	2.0 Liters/4.25 Pints
Rear Axle Oil Capacity – 7 1/2 in. Ring Gear Axle	1.66 Liters/3.5 Pints
Ring and Pinion Gear Set Type	Hypoid
Differential Lubricant (All Axles)	GM 1052271 or Equivalent
Limited Slip Additive	GM 1052358 or Equivalent

LIMITS FOR FITTING AND ADJUSTING

Pinion Bearings Preload (Measured at Pinion Yoke Nut)	
New Bearings	2.26 to 2.82 N·m (20 to 25 Lbs. In.) Rotating Torque With New Seal
Used Bearings	1.13 to 1.69 N·m (10 to 15 Lbs. In.) Rotating Torque With New Seal
Total Assembly Preload (Measured at Pinion Yoke Nut)	
New Bearings	3.95 to 4.52 N·m (35 to 40 Lbs. In.) Rotating Torque With New Seal
Used Bearings	2.26 to 2.82 N·m (20 to 25 Lbs. In.) Rotating Torque With New Seal
Ring Gear Backlash13 mm to .23 mm (.005 in. to .009 in.)























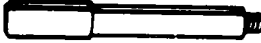



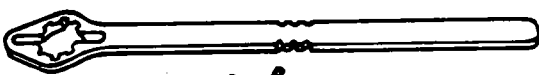
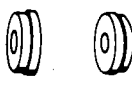
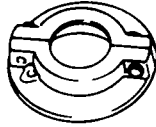
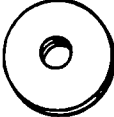
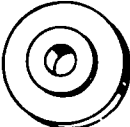

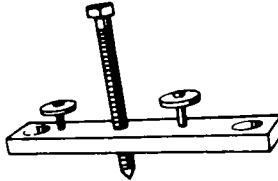

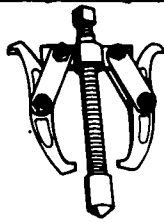

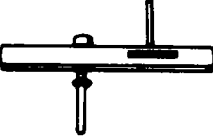

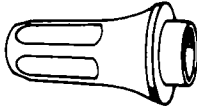





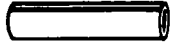
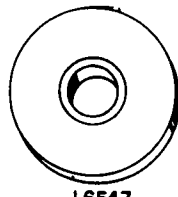

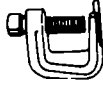

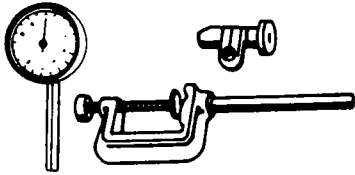

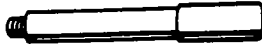

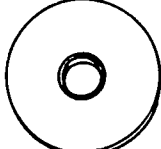

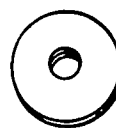
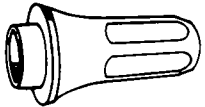
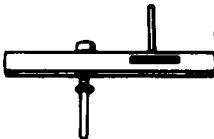
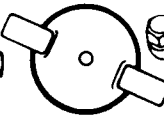
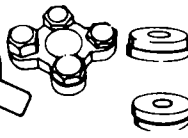

					
J 2619	J 2619-4	J 3289-01	J 3289-20	J 6133-01	
					
J 29609	BT-6623	J 6627	J 7057	J 7817 J 23765	
					
J 8001	J 8092	J 8107-2	J 8614-02	J 8614-03	
					
J 8614-10	J 8619-10 or J 21777-45	J 22912-01	J 21777-40		
					
J 21777-42	J 21777-43	J 22535-1-2-3	J 22536	J 22813-01	J 22888
					
J 22962	J 23597-1-6	J 23597-11	J 23771 J 23911	J 25299	J 25320
J 2619	SLIDE HAMMER ASSEMBLY	J 22912-01	REAR PINION BEARING REMOVER		
J 2619-4	SLIDE HAMMER ADAPTER	J 21777-40	PINION SETTING GAGE PILOT WASHER		
J 3289-01	HOLDING FIXTURE	J 21777-42	FRONT PINION BEARING PILOT		
J 3289-20	BASE ASSEMBLY	J 21777-43	PINION SETTING GAGE		
J 6133-01	FRONT PINION BEARING INSTALLER	J 22535-1-2-3	PINION HOLDING TOOL		
J 29609	PINION BEARING RACE INSTALLER	J 22536	PINION DRIVER		
BT-6623	SIDE BEARING SHIM INSTALLER	J 22813-01	AXLE SHAFT BEARING AND SEAL REMOVER		
J 6627	WHEEL STUD REMOVER	J 22888	CASE SIDE BEARING PULLER		
J 7057	DIAL INDICATOR PLUNGER EXTENSION	J 22962	CASE REMOVER ATTACHING BOLTS		
J 7817	FRONT PINION BEARING RACE INSTALLER	J 23597-1-6	BODY PINION SETTING GAGE		
J 8001	DIAL INDICATOR ASSEMBLY	J 23597-11	PINION SETTING GAGE		
J 8092	DRIVER HANDLE	J 23765	AXLE SHAFT BEARING INSTALLER		
J 8107-2	SIDE BEARING PULLER ADAPTER	J 23771	AXLE SHAFT SEAL INSTALLER		
J 8614-02	PINION FLANGE REMOVER	J 23911	PINION OIL SEAL INSTALLER		
J 8614-03	PINION FLANGE REMOVER SCREW	J 25299	SIDE BEARING INSTALLER		
J 8614-10	PINION FLANGE HOLDER	J 25320	REAR PINION BEARING REMOVER		
J 8619-10 or J 21777-45	PINION SETTING GAGE SHAFT DISCS				

Figure 42 Special Tools 7 1/2 in. Rear Axle

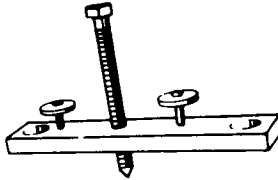
4B-26 REAR AXLE

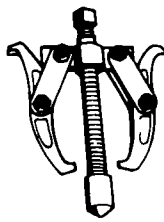
																																																																						
J 2619	J 2619-4	J 3289-01	J 3289-20	J 6133-01	J 6547	BT-6624																																																																
																																																																						
J 6627	J 7057	J 8001	J 8092	J 8107-4	J 8608	J 8611-01																																																																
																																																																						
J 8609-01	J 8612-01	J 8614-2	J 8614-3	J 8614-10	J 8619-12	or J 21777-42																																																																
																																																																						
J 21128	J 21777-1	J 21777-2	J 21777-3	J 21777-35	J 21777-43																																																																	
J 22388		or J 21777-29	or J 21777-45																																																																			
																																																																						
J 2619-4	J 22535-1-2-3	J 22536	J 22888	J 22962	J 23689	J 23690																																																																
J 2619	SLIDE HAMMER ASSEMBLY	J 2619-4	SLIDE HAMMER ADAPTER	J 3289-01	HOLDING FIXTURE	J 3289-20	BASE ASSEMBLY	J 6133-01	FRONT PINION BEARING INSTALLER	J 6547	REAR PINION BEARING INSTALLER	BT-6624	SIDE BEARING SHIM INSTALLER	J 6627	WHEEL STUD REMOVER	J 7057	DIAL INDICATOR PLUNGER EXTENSION	J 8001	DIAL INDICATOR ASSEMBLY	J 8092	DRIVER HANDLE	J 8107-4	SIDE BEARING PULLER ADAPTER	J 8608	REAR PINION BEARING RACE INSTALLER	J 8609-01	AXLE BEARING INSTALLER	J 8611-01	FRONT BEARING RACE INSTALLER	J 8612-01	REAR PINION BEARING REMOVER	J 8614-2	PINION FLANGE REMOVER	J 8614-3	PINION FLANGE REMOVER SCREW	J 8614-10	PINION FLANGE HOLDER	J 8619-12	PINION SETTING GAGE STUD WASHER	or J 21777-42	J 21128	AXLE SHAFT SEAL INSTALLER	J 21777-1	GAGE SHAFT AND PIN ASSEMBLY	J 21777-2	PINION GAGE PLATE	or J 21777-29	J 21777-3	PINION SETTING GAGE SHAFT DISCS	or J 21777-45	J 21777-35	PINION SETTING GAGE PILOT WASHER	J 21777-43	PINION SETTING GAGE	J 22175	SIDE BEARING INSTALLER	J 22388	PINION SEAL INSTALLER	J 22535-1-2-3	PINION HOLDING TOOL	J 22536	PINION DRIVER	J 22888	CASE SIDE BEARING PULLER	J 22962	CASE REMOVER ATTACHING BOLTS	J 23689	AXLE SHAFT BEARING AND SEAL REMOVER	J 23690	AXLE SHAFT BEARING INSTALLER

H38109-4B-BG

Figure 43 Special Tools 8 1/2 in. Rear Axle

CARLINE	Engine	Transmission	Engine VIN	Gear Ratio	Axle RPO	Axle Size	Standard Axle Code	Limited Slip Axle Code
B	5.0L LV2	200-4R	Y	2.73	GU2	8.5	8YB	8YP
	5.0L LV2	200-4R	Y	3.08	GU4	8.5	8YD	8YR
	5.0L LV2	200-4R	Y	3.23	GU5	8.5	8YE	8YS
G	5.0L LV2	200C	Y	2.14	G72	7.5	2AK	3BK
	3.8L LD5	200C	A	2.41	GU1	7.5	2AJ	2BJ
	5.0L LV2	200C 200-4R	Y	2.56	GM8	7.5	2AA	2BA
	3.8L LD5	200C	A	2.73	GU2	7.5	2AB	2BB
	3.8L/5.0L LD5/LV2	200-4R OR 200C	A,Y	3.08	GU4	7.5	2AC	2BC
	3.8L LD5	200C	A	3.23	GU5	7.5	2AD	2BD
	3.8L* LC2	200-4R	7	3.42	GU6	8.5	3TJ	3TP
*Turbocharged SFI								
H40000-4B-BG								

