

SECTION 3

STEERING, SUSPENSION, TIRES AND WHEELS

CONTENTS

Diagnosis	Section 3
Wheel Alignment	Section 3A
Power Rack and Pinion	Section 3B1
Manual Rack and Pinion	Section 3B2
Power Steering Pump – A, C, E, H, J & N Carlines	Section 3B3
Steering Wheels and Columns – A, C, E, H, J & N Carlines	Section 3B4
Steering Wheels and Columns – B & G Carlines	Section 3B5
Steering Linkage – B & G Carlines	Section 3B6
Power Steering Gear and Pump – B & G Carlines	Section 3B7
Front Suspension – A-C-E-H-J-N Carlines	Section 3C
Front Suspension – B-G Carline	3C2
Rear Suspension – A-C-H-J-N Carlines	Section 3D1
Rear Suspension – B-G Carline	3D2
Rear Suspension – E Carline	3D3
Tires and Wheels	Section 3E

SECTION 3 DIAGNOSIS CONTENTS

General Information	3-1	Dimmer Switch	3-11
General Diagnosis	3-1	Pivot and Switch Assembly	3-11
Manual Rack and Pinion	3-3	Steering Gear and Pump Leaks	3-11
Power Rack and Pinion	3-3	Seal Replacement Recommendations	3-12
Power Recirculating Ball	3-4	Power Steering System Test Procedure	3-12
Steering Linkage	3-5	Strut Dampener and Shock Absorber	3-12
Power Steering Pump	3-5	Tires	3-18
Steering Column		Vibrations	3-19
Lock System	3-5	Torque Steer (FWD)	3-19
Column	3-6	Sealed Wheel Bearings	3-19
Turn Signal Switch	3-7	Tapered Roller Bearings	3-19
Ignition Switch	3-8	Trim Height	3-28
Key Reminder	3-9		

GENERAL INFORMATION

Since the problems in steering, suspension, tires and wheels involve several systems, they must all be considered when diagnosing a complaint. To avoid using the wrong symptom, always road test the car first. Proceed with the following preliminary checks and correct any substandard conditions which are found.

Inspect

- Tires for wrong pressure and uneven wear
- Joints from the column to the steering gear for loose connectors or wear
- Front and rear suspension, and the steering gear or linkage for loose or damaged parts
- Out-of-round or out-of-balance tires, bent wheels, and loose and/or rough wheel bearings

- Power steering system for leaks. Also check the power steering fluid level and the pump drive belt tension

GENERAL DIAGNOSIS

Car Pulls (Leads)

Inspect

- Mismatched or uneven tires
- Broken or sagging springs
- Radial tire lateral force
- Front-wheel or rear-wheel alignment
- Steering gear valve off center (unbalanced)
- Front brakes dragging

Abnormal or Excessive Tire Wear

Inspect

- Front-wheel or rear-wheel alignment
- Sagging or broken springs
- Tire out of balance
- Worn strut dampener or shock absorber
- Hard driving
- Overloaded car
- Not rotating tires

Scuffed Tires

Inspect

- Toe incorrect
- Excessive speed on turns
- Suspension arm bent or twisted

Wheel Tramp

Inspect

- Blister or bump on tire
- Improper strut dampener or shock absorber action

Shimmy, Shake or Vibration

Inspect

- Tire or wheel out of balance
- Worn wheel bearings
- Worn tie rod ends
- Worn lower ball joints
- Excessive wheel runout
- Blister or bump on tire
- Excessive loaded radial runout of tire and wheel assembly

Hard Steering (Manual)

Inspect

- Lack of lubrication – ball joints, tie rod ends and steering gear
- Front-wheel alignment
- Steering gear adjustment

Hard Steering (Power)

Inspect

- Hydraulic system – Make test with gage J 5176 or J 25323
- Steering gear adjustment
- Bind or catch in steering gear
- Loose steering gear mounting
- Steering gear pressure port check valve (800 series)

Too Much Play In Steering

Inspect

- Wheel bearings worn
- Loose steering gear mounting
- Joints from column to steering gear loose or worn
- Steering gear adjustment

Poor Returnability (Manual)

Inspect

- Lack of lubrication – ball joints and tie rod ends
- Bind in ball joints
- Bind in steering column
- Lack of lubricant in steering gear
- Front-wheel alignment
- Steering gear adjustment

Poor Returnability (Power)

Inspect

- Lack of lubrication – ball joints and tie rod ends
- Bind in ball joints
- Bind in steering column
- Front-wheel alignment
- Steering gear adjustment
- Sticking valve
- Steering gear adjustment
- Lower coupling binding on steering gear

Abnormal Noise, Front End

Inspect

- Lubrication – ball joints and tie rod ends
- Damaged suspension components
- Worn control arm bushings or tie rod ends
- Loose stabilizer shaft
- Loose wheel nuts
- Loose suspension bolts
- Wheel covers
- Steering gear adjustment
- Worn strut dampener, shock absorbers or mountings
- Spring improperly positioned

Wander or Poor Steering Stability

Inspect

- Mismatched or uneven tires
- Lubrication – ball joints and tie rod ends
- Worn strut dampeners or shock absorbers
- Loose stabilizer shaft
- Broken or sagging springs
- Steering gear adjustment
- Front-wheel or rear-wheel alignment

Erratic Steering When Braking **Inspect**

- Wheel bearings worn
- Broken or sagging springs
- Leaking wheel cylinder or caliper
- Warped rotors
- Incorrect or uneven caster

Low Or Uneven Trim Height **Inspect**

- Broken or sagging springs
- Overloaded car
- Incorrect or weak springs

Ride Too Soft **Inspect**

- Worn strut dampeners or shock absorbers
- Incorrect or sagging springs

Ride Too Harsh **Inspect**

- Incorrect strut dampeners or shock absorbers
- Incorrect springs

Body Leans Or Sways In Corners **Inspect**

- Loose stabilizer shaft
- Worn strut dampeners, shock absorbers or mounting
- Broken or sagging springs
- Overloaded car

Suspension Bottoms **Inspect**

- Overloaded car
- Worn strut dampeners or shock absorbers
- Incorrect, broken or sagging spring

"Dog" Tracking **Inspect**

- Damaged rear suspension arm or worn bushings
- Bent rear axle
- Frame or underbody alignment incorrect

Steering Wheel Kick-Back (Power) **Inspect**

- Air in system
- Loose steering gear mounting

- Joints from column to steering gear loose or worn
- Tie rod ends loose
- Worn or missing check valve (800 series)
- Wheel bearings worn
- See "Too Much Play In Steering" for other possible causes.

Steering Wheel Surges Or Jerks (Power) **Inspect**

- Hydraulic system – Make pressure test with gage J 5176-D or J 25323
- Sluggish steering gear valve
- Loose pump drive belt

Cupped Tires **Inspect**

- Front-wheel or rear-wheel alignment
- Strut dampeners or shock absorbers weak
- Wheel bearing worn
- Excessive tire or wheel runout
- Worn ball joint
- Loose steering gear adjustment

**MANUAL RACK AND PINION
STEERING GEAR DIAGNOSIS****Excessive Play or Looseness in Steering System** **Inspect**

- Steering gear adjustment
- Wheel bearings worn
- Tie rod end loose
- Loose steering gear mounting

Rattle or Chucking Noise in Steering Gear **Inspect**

- Insufficient or improper lubricant in steering gear
- Loose steering gear mounting
- Rack bearing adjustment loose

**POWER RACK AND PINION
STEERING GEAR DIAGNOSIS****Hissing Noise**

There is some noise in all power steering systems. One of the most common is a hissing sound when the steering wheel is turned and the car is not moving. This noise will be most evident when turning the wheel while the brakes are applied. There is no relationship between this noise and steering performance. Do not replace the valve unless the "hissing" noise is extremely objectionable. A replacement valve will also have a slight noise, and is not always a cure for the condition. Check that the intermediate shaft universal joints are not loose.

POWER RECIRCULATING BALL STEERING GEAR DIAGNOSIS

Hissing Noise

There is some noise in all power steering systems. One of the most common is a hissing sound when the steering wheel is turned and the car is not moving. This noise will be most evident when turning the wheel while the brakes are applied. There is no relationship between this noise and steering performance. Do not replace the valve unless the "hissing" noise is extremely objectionable. A replacement valve will also have a slight noise, and is not always a cure for the condition. Check that the intermediate shaft joints are not loose.

Rattle or Chucking Noise

Inspect  Inspect

- Pressure hose grounding out
- The rod ends loose
- Steering gear attachment loose
- Loose pitman shaft "over-center" adjustment.
- A slight rattle may occur on turns because of increased clearance off the "high point". This is normal and clearance must not be reduced below specified limits to eliminate this slight rattle.

Poor Return of Steering Wheel to Center

Inspect  Inspect

- Front-wheel alignment
- Wheel bearing worn
- Tie rod end binding
- Ball joint binding
- Steering wheel rubbing against turn signal housing
- Steering gear adjustments
- Tight or frozen intermediate steering shaft
- Sticky or plugged spool valve

Momentary Increase in Effort When Turning Wheel Fast to Right or Left

Inspect  Inspect

- High internal leakage

Steering Wheel Surges or Jerks When Turning With Engine Running Especially During Parking

Inspect  Inspect

- Insufficient pump pressure
- Sticky flow control valve

Excessive Wheel Kickback or Loose Steering

Inspect  Inspect

- Air in system
- Steering gear attachment loose

Rattle or Chucking Noise

Inspect  Inspect

- Pressure hose grounding out
- The rod ends loose
- Loose steering gear mounting
- Rack bearing adjustment loose

Poor Return of Steering Wheel to Center

Inspect  Inspect

- Front-wheel alignment
- Wheel bearing worn
- Joints from the column to the steering gear binding or loose
- Tie rod end binding
- Ball joint binding
- Steering wheel rubbing against turn signal housing
- Tight or frozen steering shaft bearings
- Steering gear adjustments
- Sticky or plugged steering gear valve
- Steering column shaft seal rubbing shaft

Momentary Increase in Effort When Turning Wheel Fast to Right or Left

Inspect  Inspect

- High internal leakage

Steering Wheel Surges or Jerks When Turning With Engine Running Especially During Parking

Inspect  Inspect

- Insufficient pump pressure
- Sticky steering gear valve

Excessive Wheel Kickback or Loose Steering

Inspect  Inspect

- Air in system
- Steering gear attachments loose
- Joints from column to steering gear loose
- Tie rod ends loose
- Wheel bearings worn
- Loose thrust bearing preload adjustment

Hard Steering or Lack of Assist (Especially During Parking)

Inspect  Inspect

- Brakes applied while turning steering wheel
- Joints from column to steering gear loose or worn
- Sticky steering gear valve
- Insufficient pump pressure
- Excessive internal pump leakage
- Excessive internal steering gear leakage

- Tie rod ends loose
- Wheel bearings worn
- Steering gear flexible coupling loose on shaft or rubber disc mounting nuts loose
- Loose thrust bearing preload adjustment
- Excessive "over-center" lash
- Worn pressure port check valve

Hard Steering or Lack of Assist (Especially During Parking)

Inspect

- Brakes applied while turning steering wheel
- Intermediate shaft damaged or worn
- Sticky flow control valve
- Insufficient pump pressure
- Excessive internal pump leakage
- Excessive internal steering gear leakage

STEERING LINKAGE DIAGNOSIS

Excessive Play or Looseness in Steering System

Inspect

- Worn upper ball joints
- Steering gear worm bearings loosely adjusted
- Excessive pitman shaft to ball nut lash in steering gear
- Worn intermediate rod or tie rod sockets

Excessive Looseness in Tie Rod or Intermediate Rod Pivots, or Excessive Vertical Lash in Idler Support

Inspect

- Seal damage and leakage resulting in loss of lubricant, corrosion and excessive wear

Hard Steering

Inspect

- Tight or frozen intermediate rod, tie rod or idler socket
- Steering gear adjusted too tight

POWER STEERING PUMP DIAGNOSIS

Foaming, Milky Power Steering Fluid, Low Fluid Level, and Possible Low Pressure

This can be caused by air in the fluid, and loss of fluid due to internal pump leakage causing overflow. Check for leak and correct. Bleed the system. Extremely cold temperatures will cause air bubbles in the system if the fluid level is low. If the fluid level is correct and pump still foams, remove pump from car and separate reservoir from housing. Check soft plug and housing for cracks. If housing is cracked, replace housing.

Low Pressure Due to Steering Pump

Inspect

- Flow control valve stuck or inoperative
- Pressure plate not flat against cam ring
- Extreme wear of cam ring
- Scored pressure plate, thrust plate or rotor
- Vanes sticking in rotor slots
- Cracked or broken thrust or pressure plate
- High internal leakage

Low Pressure Due To Steering Gear

Inspect

- Scored housing bore
- Leakage at valve rings or seals

Growling Noise in Steering Pump

Inspect

- Excessive back pressure in hoses or steering gear caused by restriction
- Scored pressure plates, thrust plate or rotor
- Worn cam ring

Groaning Noise in Steering Pump

Inspect

- Air in the fluid
- Low fluid level
- Pump mounting loose

Rattling Noise in Steering Pump

Inspect

- Vanes sticking in rotor slots
- Vane improperly installed
- Damaged ball bearing

Swishing Noise in Steering Pump

Inspect

- Damaged flow control valve

Whining Noise in Steering Pump

Inspect

- Pump shaft bearing scored
- Scored pressure plates and vanes

STEERING COLUMN DIAGNOSIS

LOCK SYSTEM

Will Not Unlock

Inspect

- Shear flange on sector shaft collapsed

- Damaged lock bolt
- Damaged lock cylinder
- Damaged housing
- Damaged sector
- Damaged rack
- Damaged park lock cable

Will Not Lock

Inspect

- Lock bolt spring broken or worn
- Damaged sector
- Damaged lock cylinder
- Burr on lock bolt
- Damaged housing
- Improper shift linkage adjustment
- Damaged rack
- Interference between bowl and rack coupling
- Ignition switch stuck
- Actuator rod restricted
- Sector installed incorrectly
- Park lock cable damaged

High Lock Effort

Inspect

- Lock cylinder damaged
- Ignition switch damaged
- Rack preload spring broken or deformed
- Burrs on sector, rack, housing, support or actuator rod coupling
- Bent sector shaft
- Damaged rack
- Extreme misalignment of housing to cover
- Distorted coupling slot in rack
- Bent actuator rod
- Ignition switch mounting bracket bent
- Actuator rod restricted
- Improper shift linkage adjustment

Will Stick In "Start"

Inspect

- Actuator rod deformed
- Check items under "High Lock Effort"

Key Cannot Be Removed in "Off-Lock"

Inspect

- Ignition switch is not set correctly
- Damaged lock cylinder
- Linkage mis-adjusted

Lock Cylinder Can Be Removed

Inspect

- Lock cylinder retaining screw missing

High Effort In Lock Cylinder Between "Off" and "Off-Lock"

Inspect

- Distorted rack

Lock Bolt Hits Shaft Lock In "Off" Position and "Park"

Inspect

- Ignition switch is not set correctly

COLUMN

Noise In Column

Inspect

- Joints from the column to the steering gear loose
- Column not correctly aligned
- Horn contact ring not lubricated
- Lack of grease on bearings
- Loose sight shields
- Lower or upper steering shaft bearing worn or broken
- Shaft lock snap ring not seated
- Spherical joint not lubricated

High Steering Shaft Effort

Inspect

- Column assembly misaligned
- Improperly installed or deformed dust seal
- Damaged upper or lower bearing
- Flash on I.D. of shift tube
- Tight intermediate steering shaft universal joint

High Shift Effort (Automatic with Column Shift)

Inspect

- Column not aligned correctly in car
- Wave washer with burrs
- Improperly installed dust seal
- Lack of grease on seal or bearing
- Improper screws used for ignition switch
- Burr on upper or lower end of shift tube
- Lower bowl bearing not assembled correctly

Improper Shifting (Automatic with Column Shift)

Inspect

- Sheared shift tube joint or lower shift lever weld
- Improper or loose linkage adjustment
- Loose shift lever
- Improper gate plate

Lash In Steering Column **Inspect**

- I.P.-to-column upper and lower bracket mounting bolts loose
- Broken weld nuts on jacket
- I.P. upper bracket capsule sheared
- Loose shoes in housing
- Loose tilt head pivot pins
- Loose shoe lock pin in support
- Loose support screws
- Column upper and lower bracket-to-jacket bolts loose
- Loose lower bracket-to-adaptor and bearing assembly mounting screws
- Loose I.P.-to-jacket mounting bolts

Housing Scraping On Bowl **Inspect**

- Bowl bent or not concentric with hub
- Cover and housing end cap not properly installed

Steering Wheel Loose **Inspect**

- Excessive clearance between holes in support or housing and pivot pin diameters
- Damaged or missing anti-lash spring in spheres
- Upper bearing not seated in housing
- Upper bearing inner race seal missing
- Loose support screws
- Bearing preload spring missing or broken

Steering Wheel Loose (Every Other Tilt Position) **Inspect**

- Loose fit between shoe and shoe pivot pin
- Shoe not free in slot

Steering Column Not Locking In Any Tilt Position **Inspect**

- Shoe seized on its pivot pin
- Shoe grooves may have burrs or dirt
- Shoe lock spring weak or broken

Steering Wheel Fails To Return To Top Tilt Position **Inspect**

- Pivot pins are bound up
- Wheel tilt spring is broken or weak
- Turn signal switch wires too tight

Noise When Tilting Column **Inspect**

- Upper tilt bumpers worn
- Tilt spring rubbing in housing

TURN SIGNAL SWITCH

This diagnosis covers mechanical problems only. See page 8A-111-0 for turn signal switch electrical diagnosis.

Turn Signal Will Not Stay In Turn Position **Inspect**

- Foreign material or loose parts impeding movement of yoke
- Broken or missing detent or cancelling spring
- None of the above, replace switch

Turn Signal Will Not Cancel **Inspect**

- Loose switch mounting screws
- Switch or anchor bosses broken
- Broken, missing or out of position detent, return or cancelling spring
- Worn cancelling cam

Turn Signal Difficult To Operate **Inspect**

- Turn signal switch arm loose
- Yoke broken or distorted, replace switch
- Loose or misplaced springs
- Foreign parts and/or material
- Loose turn signal switch mounting screws

Turn Signal Will Not Indicate Lane Change **Inspect**

- Broken lane change pressure pad or spring hanger
- Broken, missing or misplaced lane change spring
- Jammed base or wires

Hazard Switch Cannot Be Turned Off **Inspect**

- Foreign material between hazard support cancelling leg and yoke
- If no foreign material is found, replace turn signal switch.

Hazard Switch Will Not Stay On or Difficult To Turn Off**Inspect**

- Loose turn signal switch
- Interference with other components
- Foreign material interference
- None of the above, replace turn signal switch

No Turn Signal Lights**Inspect**

- Electrical failure in chassis harness
- Inoperative turn signal flasher
- Loose chassis-to-column connector. Disconnect column-to-chassis connector and connect new turn signal switch to chassis and operate switch by hand.
 - A. If car lights now operate normally, turn signal switch is inoperative.
 - B. If car lights do not operate, refer to page 8A-111-0 for electrical diagnosis.

Turn Indicator Lights On, But Not Flashing**Inspect**

- Inoperative turn signal flasher
- Loose chassis-to-column connection
- Inoperative turn signal switch
- To determine if turn signal switch is inoperative, substitute new turn signal switch into circuit and operate switch by hand. If the car's lights operate normally, turn signal switch is inoperative.

Front Or Rear Turn Signal Lights Not Flashing**Inspect**

- Burned-out or damaged turn signal bulb
- High resistance connection to ground at bulb socket
- Loose chassis-to-column connector. Disconnect column-to-chassis connector and connect new turn signal switch into system and operate switch by hand.
 - A. If turn signal lights are now on and flashing, turn signal switch is inoperative.
 - B. If car lights do not operate, refer to page 8A-111-0 for electrical diagnosis.

Turn Indicator Panel Lights**Inspect**

Burned out bulbs or opens, grounds in the wiring harness from the front turn signal bulb socket to the indicator lights. Refer to page 8A-110-0 for electrical diagnosis.

Stop Light Not On When Turn Indicated**Inspect**

- Loose column-to-chassis connection
- Disconnect the column-to-chassis connector and connect the new turn signal switch into the system and operate the switch by hand.
 - A. If the brake lights work when the switch is in the turn position, the turn signal switch is inoperative.
 - B. If the brake lights do not work, refer to page 8A-111-0 for electrical diagnosis.

Turn Signal Lights Flash Very Slowly**Inspect**

- Loose chassis-to-column connection
- Disconnect the column-to-chassis connector and connect a new turn signal switch into the system and operate the switch by hand.
 - A. If the lights flash at a normal rate, the turn signal switch is inoperative.
 - B. If the lights still flash very slowly, refer to page 8A-111-0 for electrical diagnosis.

Hazard Signal Lights Will Not Flash - Turn Signal Functions Normally**Inspect**

- Blown fuse
- Inoperative hazard warning flasher
- Loose chassis-to-column connection
- Disconnect the column-to-chassis connector and connect a new turn signal switch into the system, then press in the hazard warning button and watch the hazard warning lights.
 - A. If the lights now work normally, the turn signal switch is inoperative.
 - B. If the lights do not flash, check the wiring harness. Refer to page 8A-111-0 for electrical diagnosis.

IGNITION SWITCH**Electrical System Will Not Function****Inspect**

- Damaged ignition switch
- Ignition switch not adjusted properly
- Loose connector at the ignition switch

Switch Will Not Turn**Inspect**

- Damaged ignition switch

Switch Cannot Be Set Correctly

Inspect

- Switch actuator rod deformed
- Sector to rack engaged in wrong tooth

KEY REMINDER

See Figures 1 through 11

Reminder Continues To Operate With Key Out, But Stops When Driver's Door Is Closed

Inspect

- Chips, foreign material in lock cylinder bore
- Sticky lock cylinder actuator tip
- Damaged or broken reminder switch

Reminder Does Not Sound With Key Fully Inserted In Lock Cylinder And The Driver's Door Open

Inspect

1. Power not available to reminder. Refer to page 8A-75-0 through 8A-77-0 for electrical diagnosis.
2. Open in chassis wiring. Check by separating chassis-to-column connector. Connect terminals "E" and "F" female contacts on the chassis connector (a bent paper clip will work). If the reminder sounds, repair chassis wiring. If the reminder does not sound, go to Step A.
 - A. Connect a continuity meter (light) to the male "E" and "F" column connector contacts. Push the key all the way into the lock cylinder. If the light is on when the key is in, and off when the key is out, the function is normal. If the light is not on, the fault is in the column. Go to Step B.

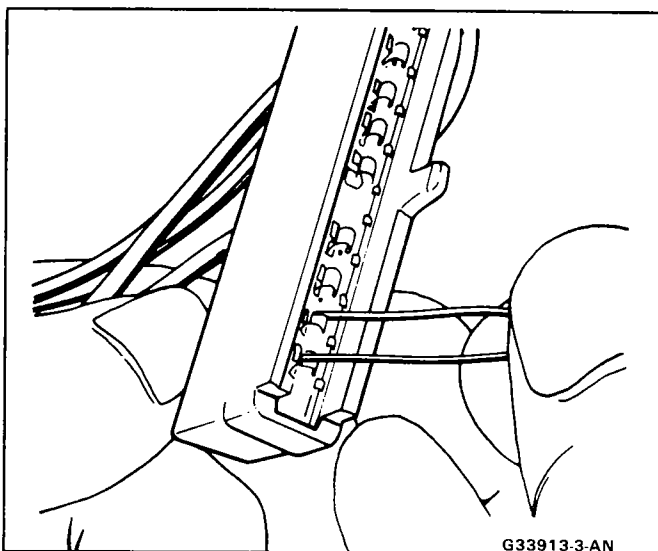

Figure 1 Checking Reminder at Chassis Connector

- B. Disassemble the upper end of the column until the turn signal switch mounting screws have been removed. Lift the turn

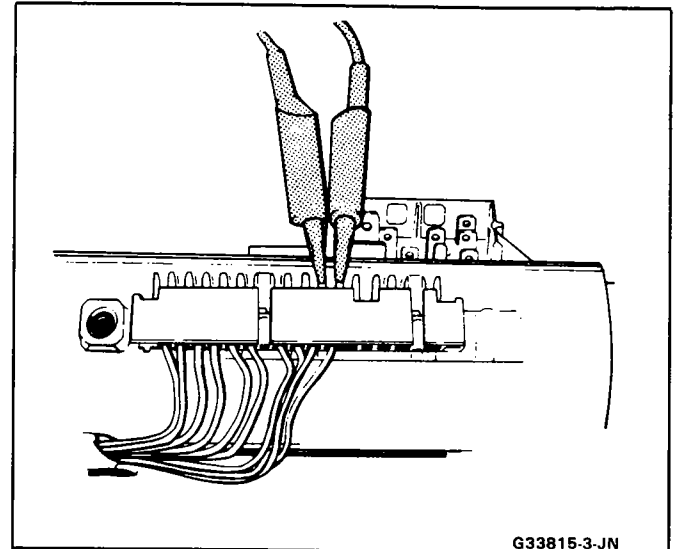

Figure 2 Checking Reminder at Column Connector

signal switch and check the probes of the reminder switch to ensure good contact with the pads on the signal switch. Bend the probes, if needed, then replace the turn signal switch and tighten the three screws. Check the function as in Step A.

3. Short or fault in the turn signal switch wiring. Connect male "E" and "F" contacts of column connector with jumper. Check key reminder switch pads on turn signal switch with continuity meter. If there is continuity, the function is normal. If not, replace the turn signal switch.
4. If the problem has not been found, connect a continuity meter (light) to the reminder switch probes on the switch. Fully insert and remove the key from the lock cylinder. If the light is on when the key is in the lock cylinder, and off when the key is out, the function is normal. Retrace the diagnostic steps starting at Step A. If the light is not on, the fault is in the lock cylinder or reminder switch.
5. Chips, burrs, or foreign material in the lock cylinder preventing actuator tip function. Remove chips, burrs, etc. Reassemble and recheck (Step 4). The key must be removed, or the cylinder must be in the "Run" position, before the lock cylinder can be removed.
6. Damaged lock cylinder. With the lock cylinder removed, push the key all the way in, then remove it. The lock cylinder actuator tip should extend and retract smoothly. Total extension of tip should be 1.27 mm (.050"). If not, replace the lock cylinder. Remove and clean as required. Reassemble and recheck per Step 4.
7. Switch appears good but will not operate. Connect continuity meter leads to the reminder switch probes on the switch. Press on the actuator pad until the switch points contact. If contact is not made, replace reminder switch.
8. Check the switch contact gap by pressing a 0.8 mm (.030") wire-type plug gage with a flat piece of stock onto the actuator pad. If contact is not made, decrease the switch contact gap until

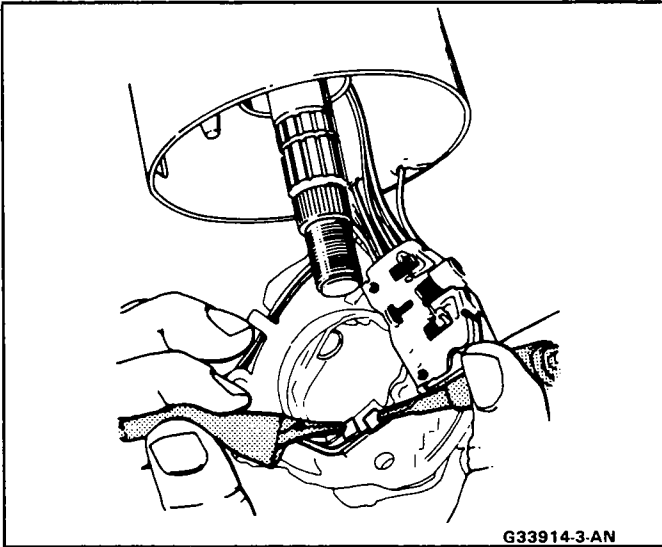

Figure 3 Checking Reminder Switch Pads

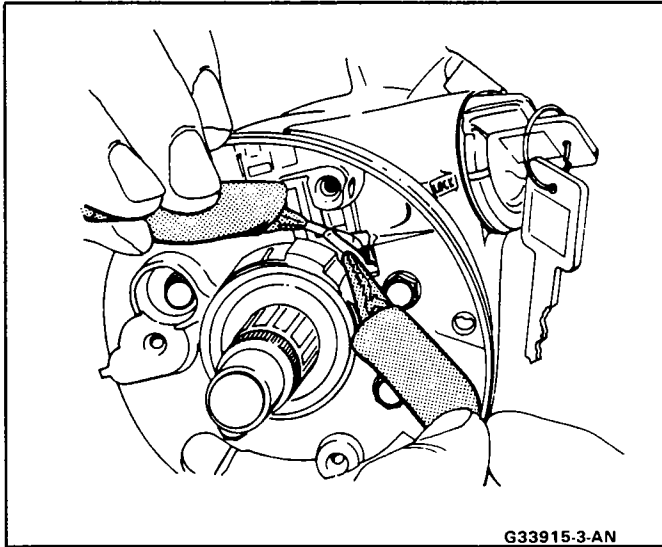

Figure 4 Checking Reminder Switch

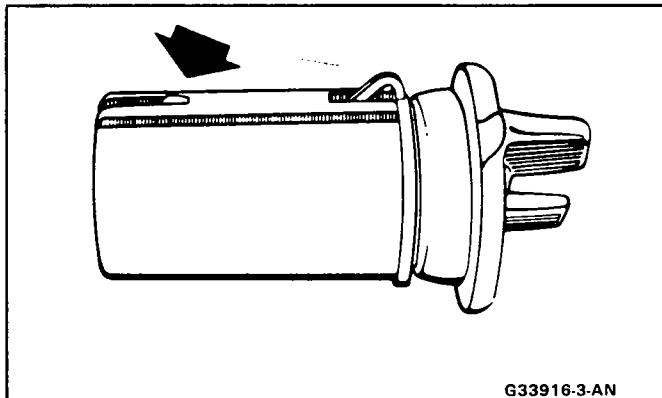

Figure 5 Lock Cylinder Actuator – Key Removed

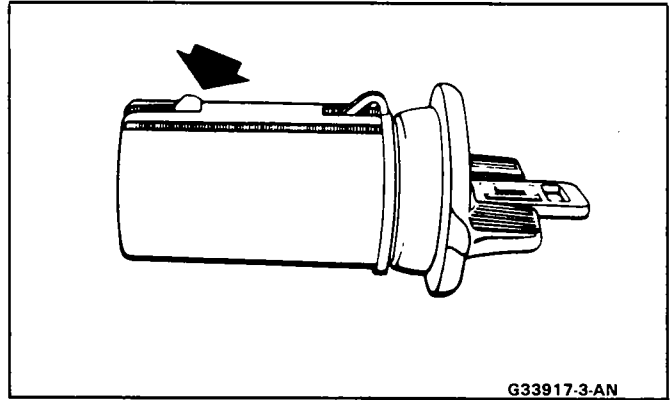

Figure 6 Lock Cylinder Actuator – Key in Place

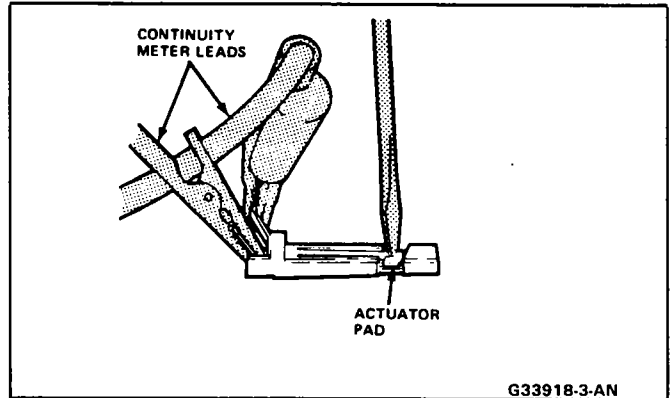

Figure 7 Checking Key Reminder Switch Continuity

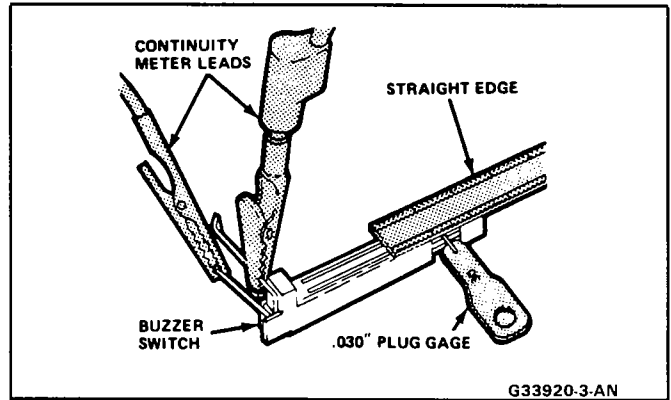

Figure 8 Checking Contact Gap

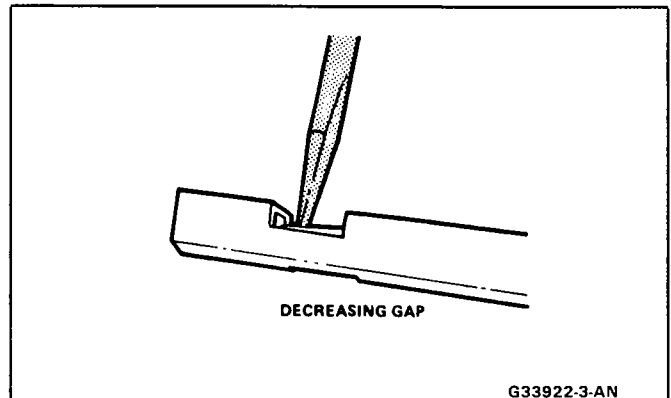

Figure 9 Decreasing Switch Contact Gap

positive contact is made. Use a continuity meter (light).

9. With positive contact at 0.8 mm (.030"), use a 0.6 mm (.025") plug gap wire beneath the flat stock. No contact should occur. If contact is made, increase the switch contact gap. When the switch will make contact with the 0.8 mm (.030") wire

but not with the 0.6 mm (.025") wire, the switch is set properly.

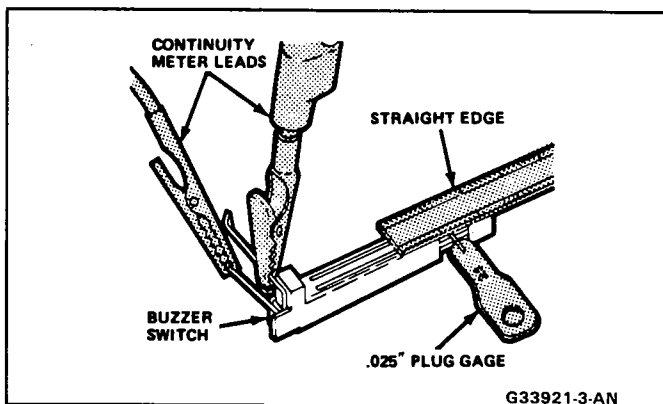

Figure 10 Checking Contact Gap

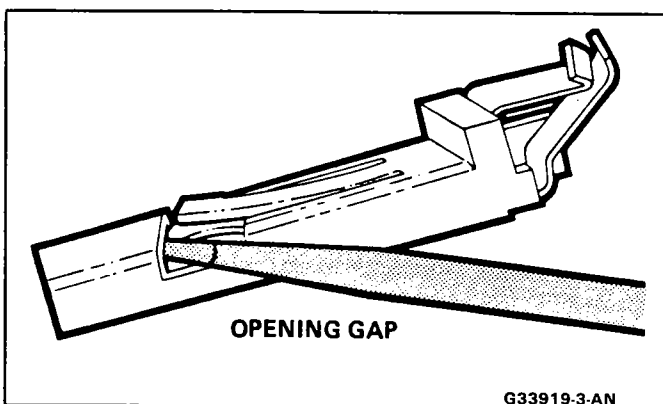

Figure 11 Increasing Switch Contact Gap

Reminder Keeps Operating With Key In Lock Cylinder, Driver's Door Open Or Closed; Ceases When Key Is Removed

Inspect

- Door jamb switch on driver's side misadjusted or inoperative.
- Wire from signal switch to door jamb switch shorted.
 - A. This condition indicates the lock cylinder or the reminder switch is at fault. To verify, check for continuity at the "E" and "F" male column connector contacts, with the key removed from the lock cylinder. If continuity exists, the fault is in the column.
 - B. Insert the key into the lock, then turn the lock toward the "Start" position. If the reminder stops when the key is in the "Run" position or when it is turned past "Run" toward "Start," the problem is a sticky lock cylinder actuator.

COLUMN-MOUNTED DIMMER SWITCH

No "Low" or "High" Beam

Inspect

- Loose connector at dimmer switch

- Improper adjustment
- Internally damaged or worn switch. Check the continuity on the switch at the lt. green and at the tan switch terminals by pushing in the plunger all the way. A click should be heard. If there is no continuity, replace the dimmer switch. If there is continuity, refer to page 8A-100-0 or 8A-101-0 for electrical diagnosis.

PIVOT AND SWITCH ASSEMBLY

Switch Inoperative: No "Low," "High" and/or "Wash"

Inspect

- Loose body-to-switch connector
- Broken or damaged switch
- Internally damaged or worn switch. Connect a new switch without removing the old one. If the system functions, replace the switch. If the system doesn't function, refer to page 8A-90-0 or 8A-91-0 for electrical diagnosis.

STEERING GEAR AND PUMP LEAKS

General Procedure

Inspect

- Overfilled reservoir
- Fluid aeration and overflow
- Hose connections
- Verify exact point of leakage

Example: Torsion bar, stub shaft and adjuster seals are close together; the exact spot where the system is leaking may not be clear.

Example: The point from which the fluid is dripping is not necessarily the point where the system is leaking; fluid overflowing from the reservoir, for instance.

- When service is required:
 - A. Clean leakage area upon disassembly.
 - B. Replace leaking seal.
 - C. Check component sealing surfaces for damage.
 - D. Reset bolt torque to specifications, where required.
- Some complaints about the power steering system may be reported as:
 - A. Fluid leakage on garage floor
 - B. Fluid leaks visible on steering gear or pump
 - C. Growling noise, especially when parking or when engine is cold
 - D. Loss of power steering when parking
 - E. Heavy steering effort

When troubleshooting these kinds of complaints, check for an external leak in the power steering system.

For further diagnosis of leaks, refer to External Leakage Check in this section.

External Leakage Check

See Figures 12 thru 15

The purpose of this procedure is to pinpoint the location of the leak.

In some cases, the leak can easily be located. But, seepage-type leaks may be more difficult to isolate. To locate seepage leaks, use the following method.

1. With the engine off, wipe dry the complete power steering system.
2. Check the fluid level in the pump's reservoir. Add fluid if necessary.
3. Start the engine, then turn the steering wheel from stop to stop several times. Do not hold it at a stop for any length of time, as this can damage the power steering pump. It is easier if someone else operates the steering wheel while you search for the seepage.
4. Find the exact area of the leak and repair leak.

SEAL REPLACEMENT RECOMMENDATIONS

Lip seals, which seal rotating shafts, require special treatment. This type of seal is used on the steering gear and on the drive shaft of the pump. When there is a leak in one of these areas, always replace the seal(s), after inspecting and thoroughly cleaning the sealing surfaces. Replace the shaft only if very severe pitting is found. If the corrosion in the lip seal contact zone is slight, clean the surface of the shaft with crocus cloth. Replace the shaft only if the leakage cannot be stopped by first smoothing with crocus cloth.

POWER STEERING SYSTEM TEST PROCEDURE

See Figure 16

1. Disconnect pressure hose at pump. Use a small container to catch any fluid which might leak.
2. Connect a spare pressure hose to pump.
3. Connect pressure gage J 5176-D to both hoses.
 - The power steering system may be tested using J 5176-D as described here. It can also be tested with available tool J 25323 Power Steering Analyzer, which will measure flow rate as well as pressure.
4. Open valve on gage.
5. Start the engine. Allow the system to reach operating temperature, then check the fluid level and add fluid if required.
6. When the engine is at normal operating temperature, the pressure reading on the gage (valve open) should be in the 552-862 kPa (80-125 psi) range. If the pressure is more than 1 380 kPa (200 psi), check the hoses for restrictions and the poppet valve on the steering gear for proper assembly.
7. Fully close the valve 3 times. (Do not leave the valve fully closed for more than 5 seconds, as the pump could be damaged.) Record the pressure reading each time the valve is closed. Each reading should show at least 6 895 kPa (1,000 psi), or at least 8 619 kPa (1,250 psi) on the TC

series pumps. The three readings should be within 345 kPa (50 psi) of each other.

- A. If the pressure readings are high enough, and are within 345 kPa (50 psi) of each other, the pump is functioning properly.
 - B. If the pressure readings are high enough, but are not within 345 kPa (50 psi) of each other, the flow control valve in the pump is sticking. Remove the valve; clean it and remove any burrs using crocus cloth or fine hone. If the system contains some dirt, flush it. If it is exceptionally dirty, both the pump and the steering gear must be completely disassembled, cleaned and reassembled.
 - C. If the pressure readings are less than 6 895 kPa (1,000 psi), or are less than 8 619 kPa (1,250 psi) on the TC series pumps, replace the flow control valve and recheck. If the pressures are still low, replace the rotor and vanes.
8. If the pump checks to specification, leave the valve open and turn (or have turned) the steering wheel to both stops. Record the highest pressures and compare with the highest pump pressure recorded. If the pressure at both stops is not the same as the maximum pressure, the steering gear is leaking internally and must be disassembled and repaired.
 9. Turn off the engine, then remove the testing gage and the spare hose. Reconnect the pressure hose, check the fluid level or make needed repairs.

STRUT DAMPENER AND SHOCK ABSORBER DIAGNOSIS

The strut dampener is basically a shock absorber. Strut dampeners are easier to extend and retract by hand than are shock absorbers.

The following procedure includes both on-car and bench checks to be done when evaluating the performance of strut dampeners and shock absorbers.

ON-CAR CHECKS

Weak

For struts, follow Steps 1 through 4.

1. Check and adjust tire pressures to the pressures shown on the Tire Placard.
2. Note the load conditions under which the car is normally driven.
3. If practical, ride with the owner to be sure you understand the complaint before proceeding to next step.
4. Test each strut dampener/shock in turn by quickly pushing down, then lifting up, the corner of the bumper nearest the strut dampener/shock being checked. Use the same amount of effort on each test and note the resistance on compression and rebound. Compare this with a similar car having acceptable ride quality. Both strut dampeners/shocks should provide the same feeling of resistance.

If there is much difference between the right and left rear shocks, go to the next step.

RACK & PINION AND PUMP LEAK DIAGNOSIS

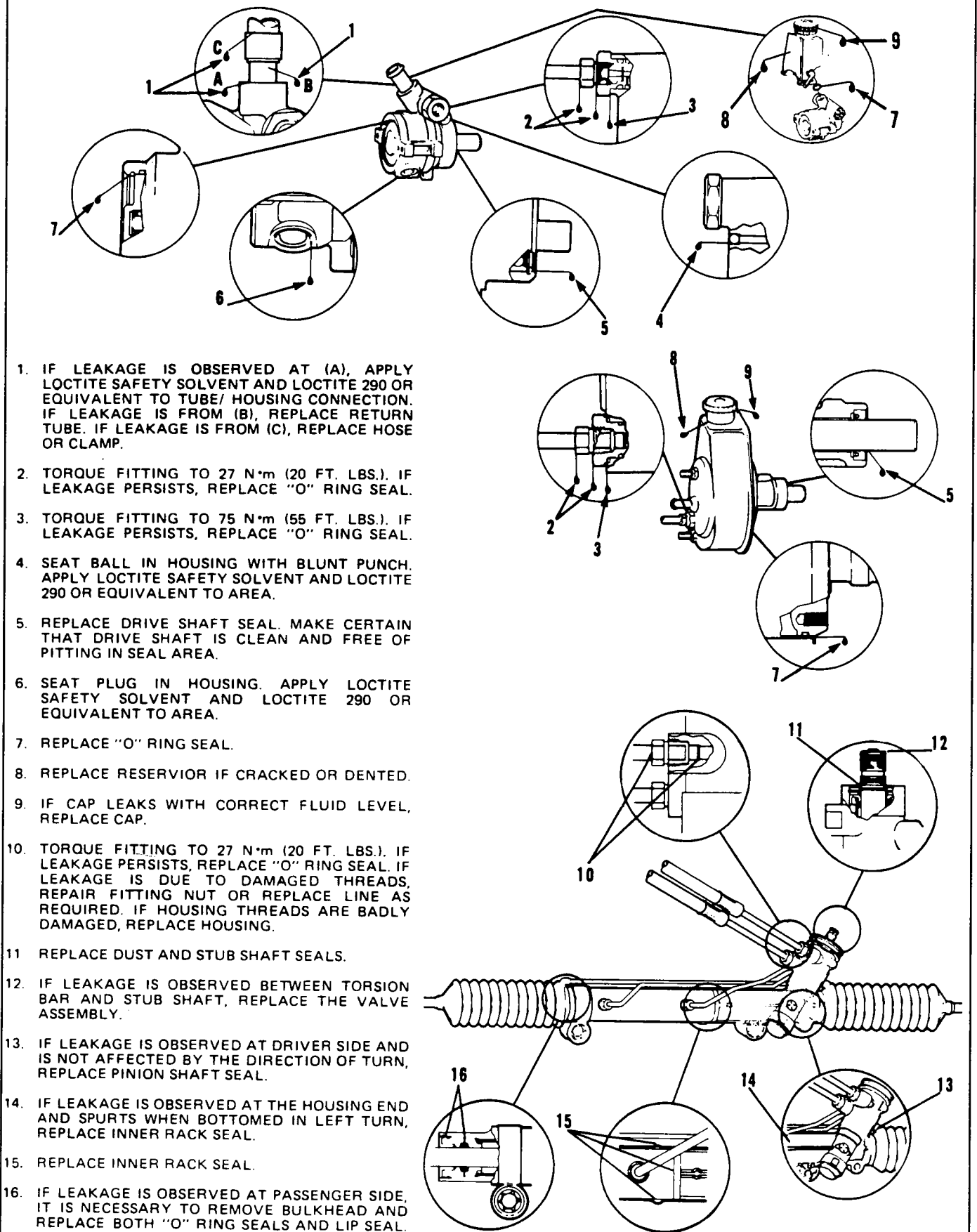

1. IF LEAKAGE IS OBSERVED AT (A), APPLY LOCTITE SAFETY SOLVENT AND LOCTITE 290 OR EQUIVALENT TO TUBE/ HOUSING CONNECTION. IF LEAKAGE IS FROM (B), REPLACE RETURN TUBE. IF LEAKAGE IS FROM (C), REPLACE HOSE OR CLAMP.
2. TORQUE FITTING TO 27 N·m (20 FT. LBS.). IF LEAKAGE PERSISTS, REPLACE "O" RING SEAL.
3. TORQUE FITTING TO 75 N·m (55 FT. LBS.). IF LEAKAGE PERSISTS, REPLACE "O" RING SEAL.
4. SEAT BALL IN HOUSING WITH BLUNT PUNCH. APPLY LOCTITE SAFETY SOLVENT AND LOCTITE 290 OR EQUIVALENT TO AREA.
5. REPLACE DRIVE SHAFT SEAL. MAKE CERTAIN THAT DRIVE SHAFT IS CLEAN AND FREE OF PITTING IN SEAL AREA.
6. SEAT PLUG IN HOUSING. APPLY LOCTITE SAFETY SOLVENT AND LOCTITE 290 OR EQUIVALENT TO AREA.
7. REPLACE "O" RING SEAL.
8. REPLACE RESERVIOR IF CRACKED OR DENTED.
9. IF CAP LEAKS WITH CORRECT FLUID LEVEL, REPLACE CAP.
10. TORQUE FITTING TO 27 N·m (20 FT. LBS.). IF LEAKAGE PERSISTS, REPLACE "O" RING SEAL. IF LEAKAGE IS DUE TO DAMAGED THREADS, REPAIR FITTING NUT OR REPLACE LINE AS REQUIRED. IF HOUSING THREADS ARE BADLY DAMAGED, REPLACE HOUSING.
11. REPLACE DUST AND STUB SHAFT SEALS.
12. IF LEAKAGE IS OBSERVED BETWEEN TORSION BAR AND STUB SHAFT, REPLACE THE VALVE ASSEMBLY.
13. IF LEAKAGE IS OBSERVED AT DRIVER SIDE AND IS NOT AFFECTED BY THE DIRECTION OF TURN, REPLACE PINION SHAFT SEAL.
14. IF LEAKAGE IS OBSERVED AT THE HOUSING END AND SPURTS WHEN BOTTOMED IN LEFT TURN, REPLACE INNER RACK SEAL.
15. REPLACE INNER RACK SEAL.
16. IF LEAKAGE IS OBSERVED AT PASSENGER SIDE, IT IS NECESSARY TO REMOVE BULKHEAD AND REPLACE BOTH "O" RING SEALS AND LIP SEAL.

G33910-3-AN

Figure 12 Tie Rod End-Take-Off Power Rack & Pinion and TC and P Series Pump Leak Diagnosis

RACK & PINION AND PUMP LEAK DIAGNOSIS

C TORQUE CYLINDER LINE FITTING TO 18 N·m (13 FT. LBS.). IF LEAKAGE PERSISTS, REPLACE BOTH "O" RINGS.

IF LEAKAGE IS DUE TO DAMAGED THREADS, REPAIR FITTING NUT OR REPLACE CYLINDER LINE AS REQUIRED. IF HOUSING THREADS ARE BADLY DAMAGED, REPLACE HOUSING.

A IF SEEPAGE IS OBSERVED BETWEEN TORSION BAR AND STUB SHAFT, REPLACE THE VALVE ASSEMBLY.

REPLACE DUST AND STUB SHAFT SEALS.

B TORQUE HOSE FITTING TO 27 N·m (20 FT. LBS.). IF LEAKAGE PERSISTS, REPLACE "O" RING. IF LEAKAGE IS DUE TO DAMAGED THREADS, REPAIR FITTING NUT OR REPLACE HOSE AS REQUIRED. IF HOUSING THREADS ARE BADLY DAMAGED, REPLACE HOUSING.

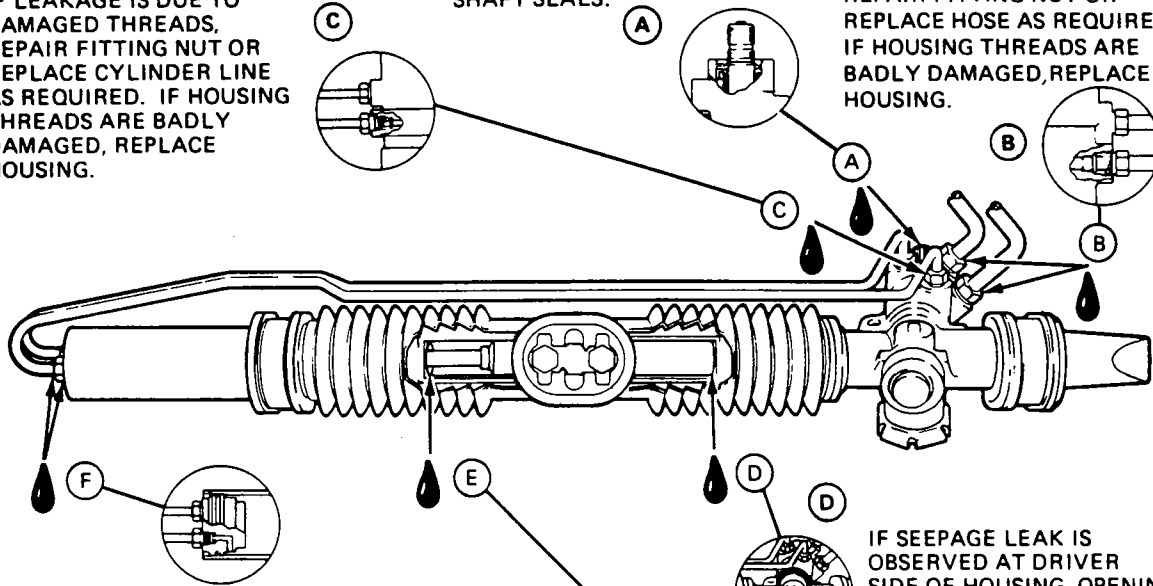

IF SEEPAGE LEAK IS OBSERVED AT DRIVER SIDE OF HOUSING OPENING, REPLACE PINION SHAFT SEAL.

F IF LEAKAGE IS OBSERVED AT PASSENGER SIDE END IT IS NECESSARY TO REMOVE BULKHEAD AND REPLACE "O" RING SEAL.

TORQUE CYLINDER FITTING TO 18 N·m (13 FT. LBS.). IF

LEAKAGE PERSISTS, REPLACE "O" RING SEAL. IF LEAKAGE IS DUE TO DAMAGED THREADS, REPAIR FITTING NUT OR REPLACE CYLINDER LINE. IF BULKHEAD THREADS ARE BADLY DAMAGED REPLACE BULKHEAD.

E IF LEAKAGE IS OBSERVED AT CYLINDER END AND SPURTS WHEN BOTTOMED IN LEFT TURN, REPLACE THE PISTON ROD GUIDE SEAL AND "O" RING SEAL.

A REPLACE "O" RING SEAL.

B TORQUE FITTING TO 27 N·m (20 FT. LBS.). IF LEAKAGE PERSISTS, REPLACE "O" RING SEAL.

C TORQUE FITTING TO 75 N·m (55 FT. LBS.). IF LEAKAGE PERSISTS, REPLACE "O" SEAL.

D IF LEAKAGE IS OBSERVED AT (1), APPLY LOCTITE SAFETY SOLVENT AND LOCTITE 290 OR EQUIVALENT TO TUBE/HOUSING CONNECTION. IF LEAKAGE IS FROM (2), REPLACE TUBE. IF LEAKAGE IS FROM (3), REPLACE HOSE OR CLAMP.

E REPLACE DRIVE SHAFT SEAL. MAKE CERTAIN THAT DRIVE SHAFT IS CLEAN AND FREE OF PITTING IN SEAL AREA.

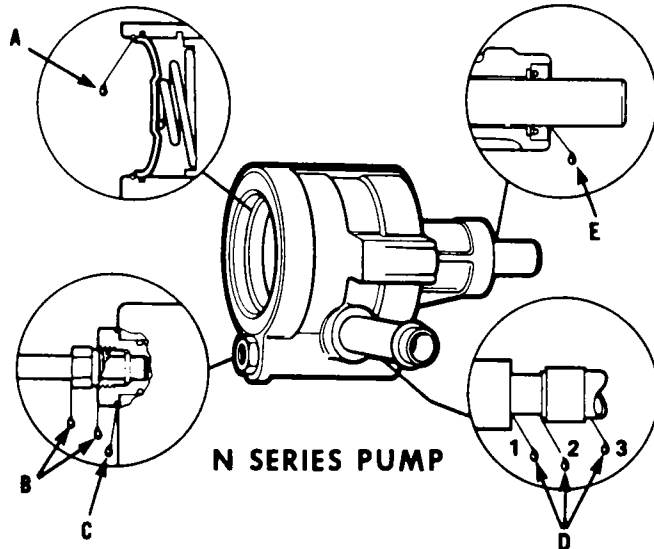

N SERIES PUMP

Figure 13 Tie Rod Center-Take-Off Power Rack & Pinion and N Series Pump Leak Diagnosis

GEAR AND PUMP LEAK DIAGNOSIS

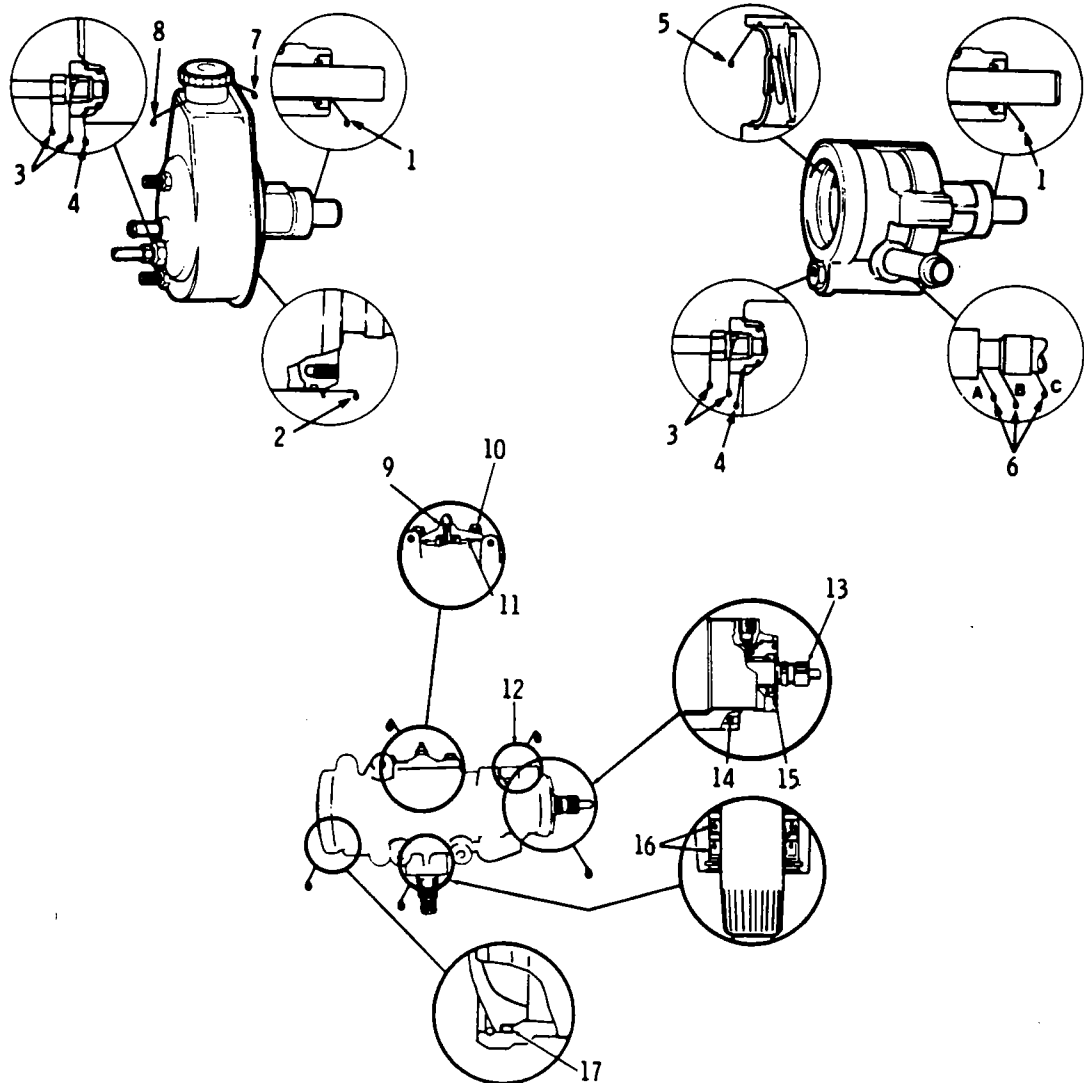

1. REPLACE DRIVE SHAFT SEAL. MAKE CERTAIN THAT DRIVE SHAFT IS CLEAN AND FREE OF PITTING IN SEAL AREA.
2. REPLACE RESERVOIR O-RING SEAL.
3. TORQUE HOSE FITTING NUT TO 35 N·m (25 FT. LBS.). IF LEAKAGE PERSISTS, REPLACE O-RING SEAL.
4. TORQUE FITTING TO 75 N·m (55 FT. LBS.). IF LEAKAGE PERSISTS, REPLACE O-RING SEAL.
5. REPLACE O-RING SEAL.
6. IF LEAKAGE IS OBSERVED AT (A), FOLLOWING MANUFACTURER'S DIRECTIONS, APPLY LOCTITE 75559 SOLVENT AND LOCTITE 290 ADHESIVE, OR EQUIVALENT, TO TUBE-HOUSING CONNECTION. IF LEAKAGE IS COMING FROM (B), REPLACE RETURN TUBE. IF COMING FROM (C), REPLACE HOSE OR CLAMP.
7. CHECK OIL LEVEL; IF LEAKAGE PERSISTS WITH THE LEVEL CORRECT AND CAP TIGHT, REPLACE THE CAP.
8. IF A CRACKED OR BENT RESERVOIR IS DETECTED, REPLACE RESERVOIR.
9. TORQUE NUT TO 48 N·m (35 FT. LBS.). REPLACE NUT IF LEAKAGE PERSISTS.
10. TORQUE SIDE COVER BOLTS TO 60 N·m (45 FT. LBS.). REPLACE SIDE COVER SEAL IF LEAKAGE PERSISTS.
11. REPLACE SIDE COVER O-RING SEAL.
12. TORQUE HOSE FITTING NUT TO 27 N·m (20 FT. LBS.). IF LEAKAGE PERSISTS, REPLACE O-RING SEAL.
13. REPLACE ROTARY VALVE ASSEMBLY.
14. SEAT BALL FLUSH WITH PUNCH AND RESTAKE. IF SEEPAGE PERSISTS, REPLACE HOUSING.
15. REPLACE ADJUSTER PLUG SEALS.
16. REPLACE BOTH PITMAN SHAFT SEALS.
17. REPLACE END PLUG O-RING SEAL.

Figure 14 Steering Gear and N & P Series Pump Leak Diagnosis

POWER RACK AND PINION OFF-CAR LEAK TEST-TYPICAL

Parts Required

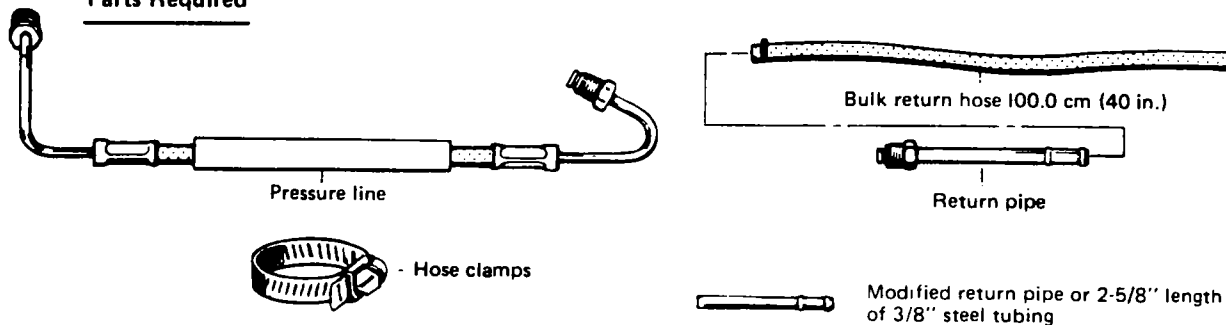

Setting Up and Testing

1. Cut clamp holding return hose from steering gear to return line from pump. Discard clamp.
2. Disconnect return hose from return line.
3. Slip end of bulk hose and return pipe assembly over end of return line from pump and secure with clamp.
4. Connect fitting end of return hose and pipe assembly to return part of rack and pinion assembly. Torque to 27 N·m (20 Lbs. Ft.)
5. Disconnect pressure pipe from steering gear
6. Connect pressure hose of suitable length Torque to 27 N·m (20 Lbs. Ft.)
7. Connect other end of pressure to hose to rack and pinion steering gear assembly. Torque to 27 N·m (20 Lbs. Ft.)
8. Start engine and allow to idle about 10 seconds then stop engine.
9. Check power steering fluid level and adjust as necessary.
10. Start engine and turn rack and pinion stub shaft to full turn in each direction. Hold against each stop for about 5 seconds.

11. Observe possible leak points and repair as necessary.
12. Pressure checks (Gage J-5176-02) or pressure and flow checks (Analyzer J-25323 or equivalent) may also be conducted using this set up.

Reinstallation

1. Disconnect test pressure hose and return line from pressure pipe and return line on car.
2. Connect original pressure hose and return line to pressure pipe and return line on car.
3. Remove test pressure hose and return line from steering gear.
4. Install rack and pinion assembly in car and connect pressure and return lines.
5. Start engine and allow it to idle for about 10 seconds.
6. Stop engine and check power steering fluid. Add fluid as necessary.

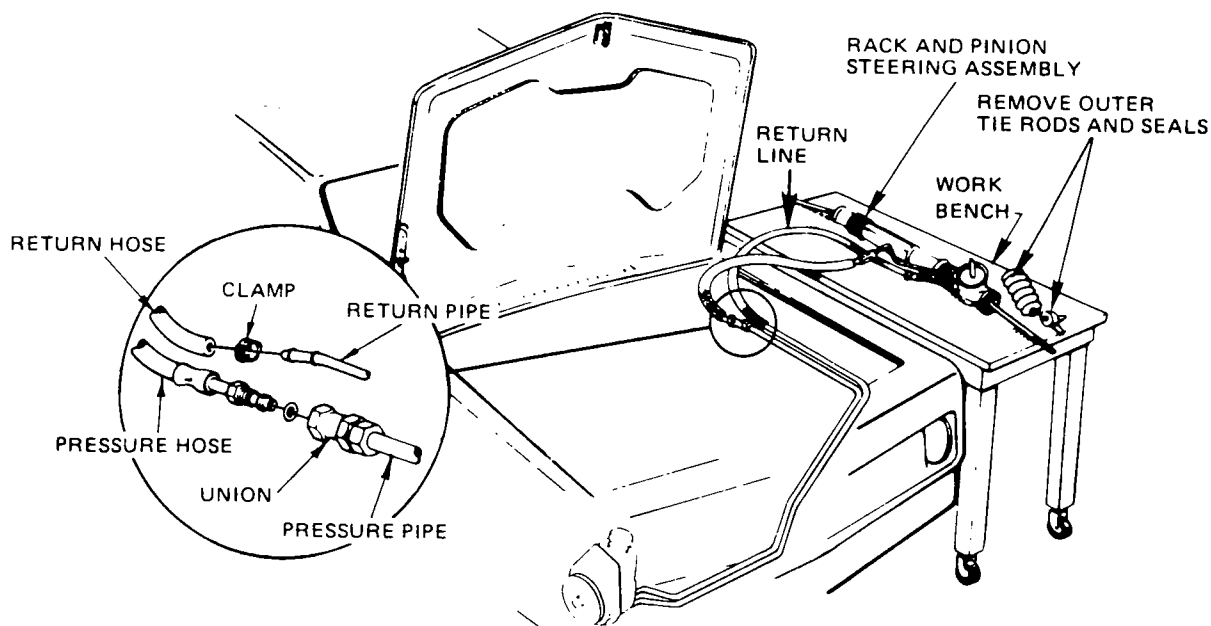

Figure 15 Power Rack & Pinion Off-Car Leak Test - (Typical)

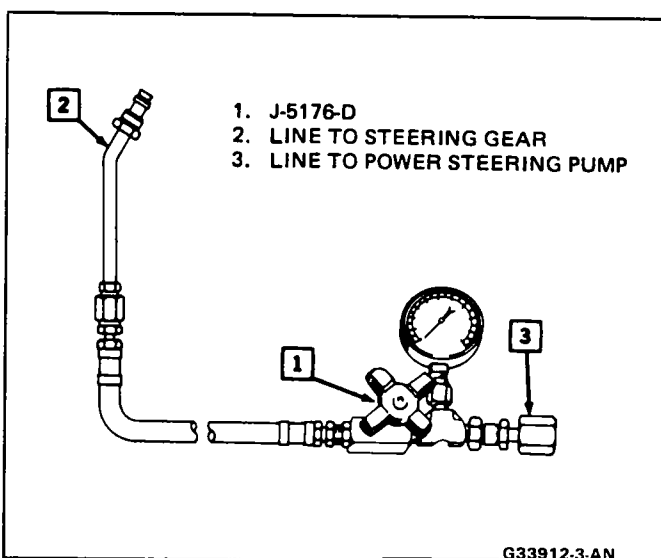

Figure 16 Power Steering Pressure Gage

5. Support the rear axle at least enough to unload the shock mounts.
6. Disconnect the lower shock mountings. Stroke the shocks at various rates of speed, through maximum travel in both directions. Compare the two sides for rebound and compression resistance. Rebound resistance is normally stronger than compression (about 2 to 1). The right and left shocks must feel comparable. Differences between front and rear are normal. If in doubt about the condition, compare with a shock known to be good.

Noisy

For struts, follow Steps 1 through 3.

1. Check all mountings for proper torque. A loose mounting will cause a noise.
2. If all mountings are intact, bounce the car as in Step 4 (weak) to isolate the suspected unit.
3. If practical, ride with the owner to be sure you understand the complaint, before proceeding to next step.
4. If one of the rear shocks is noisy, the rear axle should be supported at least enough to unload the shock mounts. Disconnect the lower mounting of the suspected shock. Quickly push the shock all the way in, then all the way out. A hissing noise is normal.
5. Other objectionable noises may be detected by stroking. Any sound other than hissing is abnormal; replace the shock.

Leaks

1. Fully extend the strut/shocks (wheels unsupported) to expose the seal cover area for inspection.
2. Look for signs of leaks in the seal cover area.
3. A slight trace of fluid is NOT cause for replacement; the seal permits some seepage to lubricate the piston rod. There is a built in fluid reserve to allow for seepage.

4. A leaking strut dampener/shock can easily be found because there will be fluid around the seal cover and an excessive amount of fluid on the strut dampener/shock. A leaking strut dampener/shock must be replaced.

BENCH CHECKS

Electronic Level Control Strut Dampeners and Shocks

All ELC strut dampeners/shocks should be stroked before attempting a bench check. When stored horizontally, such as new units in stock, an air pocket will develop in the pressure chamber. This pocket can also form when an ELC strut dampener/shock is off the car, if it is not continuously held with the top end up.

Do the following to remove air from the pressure chamber:

Extend in vertical position – top end up.

Collapse in vertical position – top end down.

Do this again five (5) more times to make sure air is purged from the pressure chamber.

Proceed with the actual bench check as follows:

1. Clamp a vise on the bottom mount with the strut dampener/ shock upright in the vise – top end up. Do not clamp on the reservoir tube or the mounting threads.
2. Pump strut dampener/shock by hand at various rates of speed and note the resistance.
3. Rebound resistance normally is stronger than compression resistance by about 2 to 1. However, the resistance should be smooth and constant for each stroking rate.
4. Compare with a strut dampener/ shock known to be good.
5. It is normal to hear a hissing noise. The following symptoms are abnormal and are reason for replacement.
 - A. A skip or lag at reversal near mid-stroke.
 - B. A seize (except at either extreme end of travel).
 - C. A noise (such as a grunt or squeal) after completing one full stroke in both directions.
 - D. A clicking noise at fast reversal.
 - E. Fluid leakage.

Strut Dampeners and Regular Shock Absorbers (Standard and Firm Ride)

Regular strut dampeners/rear shocks use a gas-filled cell in the fluid reservoir. Aeration or foaming of the fluid is eliminated, as the gas and the fluid cannot mix.

The bench check is the same as that given for the Electronic Level Control strut dampeners/ shock absorbers, with the following exception.

Clamp the strut dampener/shock UPSIDE DOWN in the vise. If a lag is noticed when it is stroked, it means the gas-filled cell has ruptured and replacement is necessary.

TIRE DIAGNOSIS

Irregular and Premature Wear

See Figures 17 and 18

Irregular and premature tire wear has many causes. Some of them are: incorrect inflation pressures, lack of regular rotation, driving habits, or improper wheel alignment. If wheel alignment is reset due to a tire wear condition, always reset toe as close to zero degrees as the specification allows.

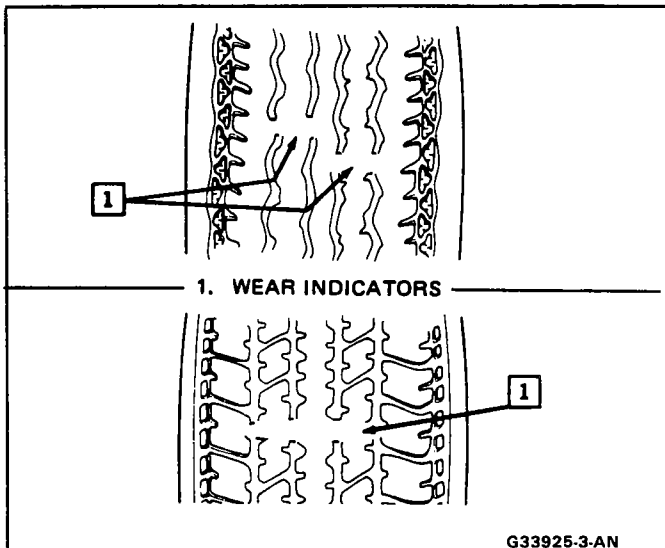

Figure 17 Tire Wear Indicator

If the following conditions are noted, rotate the tires:

- Front tire wear is different from rear.
- Uneven wear exists across the tread of any tire.
- Left and right front tire wear is unequal.
- Left and right rear tire wear is unequal.

Check wheel alignment if the following conditions are noted:

- Left and right front tire wear is unequal.
- Wear is uneven across the tread of any front tire.

- Front tire treads have a scuffed appearance with “feather” edges on one side of the tread ribs or blocks.

Wear Indicators

See Figure 17

The original equipment tires have built-in tread wear indicators to show when the tires should be replaced. These indicators will appear as 12.7 mm (1/2”) wide bands when the tire tread depth becomes 1.6 mm (2/32”). When the indicators appear in 2 or more grooves at 3 locations, replace the tire.

Radial Tire Waddle

See Figure 19

Waddle is side-to-side movement at the front and/or rear of the car. It can be caused by the steel belt not being straight within the tire, or by excessive lateral runout of the tire or wheel. It is most noticeable at low speed, about 8 to 48 km/h (5 to 30 mph). It may also appear as a ride roughness at 80 to 113 km/h (50 to 70 mph).

The car can be road tested to see which end of the car has the faulty tire. If the tire causing the waddle is on the rear, the rear end of the car will “waddle.” From the driver’s seat, it feels as if someone is pushing on the side of the car.

If the faulty tire is on the front, the waddle is more easily seen. The front sheet metal appears to be moving back and forth. It feels as if the driver’s seat is the pivot point in the car.

Another more time-consuming method of determining the faulty tire is substituting tire and wheel assemblies that are known to be good. Follow these steps:

1. Drive the car to determine if the waddle is coming from the front or rear.
2. Install tire and wheel assemblies known to be good (from a similar car) in place of those on the end of the car which is waddling. If the waddle

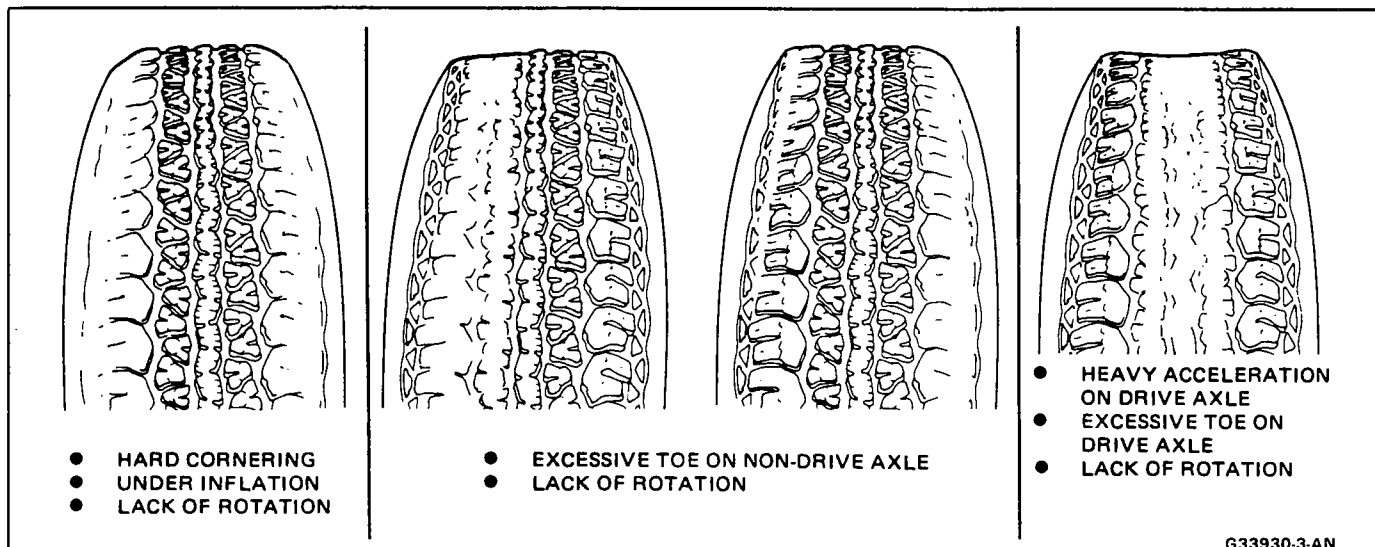

Figure 18 Tire Wear Diagnosis

cannot be isolated to front or rear, start with the rear tires.

3. Road test again. If improvement is noted, install the original tire and wheel assemblies one at a time until the faulty tire is found. If no improvement is noted, install tires known to be good in place of all four. Then, install the originals one at a time until the faulty tire is found.

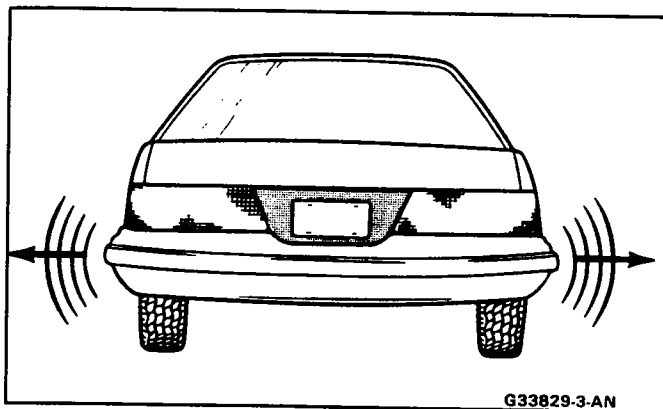

Figure 19 Tire Waddle

Radial Tire Lead/Pull

See Figures 20 and 21

“Lead/Pull” is the deviation of the car from a straight path, on a level road with no pressure on the steering wheel.

Lead is usually caused by:

1. Tire construction.
2. Uneven brake adjustment.
3. Wheel alignment.

The way in which a tire is built can produce lead in a car. An example of this is placement of the belt. Off-center belts on radial tires can cause the tire to develop a side force while rolling straight down the road. The tire will tend to roll like a cone.

The Radial Tire Lead/Pull Correction Chart should be used to make sure that front wheel alignment is not mistaken for tire lead.

Rear tires will not cause lead.

VIBRATION DIAGNOSIS

See Figures 22 through 24 for vibration diagnosis.

TORQUE STEER - FRONT-WHEEL-DRIVE CARS

A degree of torque steer to the right may normally be experienced during heavy throttle application on some front-wheel-drive cars that do not have equal length drive axles. This is due to the right drive axle being longer than the left axle and associated difference in axle angle. Cars with intermediate axle shafts have almost equal length axles.

A difference in axle length results in more torque toe-in effect to the left front wheel. This condition can be noticed when accelerating from a standing start or at lower speeds. A simple measurement to determine the degree of torque steer is to place a small piece of tape at the top center of the steering wheel. Drive the

car and note the inches of steering wheel deflection required to steer the car straight under heavy acceleration. A comparison of like cars will then determine if a particular car has a greater than normal degree of torque steer. The following factors may cause torque steer to be more apparent on a particular car:

- A slightly smaller diameter tire on the right front will increase a right torque lead. Inspect front tires for difference in brand, construction, or size. If the tires appear similar, change the front tires side to side and retest the car. Tire and wheel assemblies have the most significant effect on torque steer correction.
- Large difference in right and left front tire pressure.
- Any looseness in control arm bushings, tie rod assemblies or steering gear mounting which permits a front wheel to pull forward and toe-in under torque more than the opposite side. A loose suspension component may also result in an opposite lead on deceleration.
- High front trim height which would increase drive axle angle.
- Binding or tight drive axle joint. A tight joint or high front trim height may also exhibit a wobble condition between 15 and 30 mph.
- Incorrect, worn, or loose engine mounts causing adverse drive axle angles.

The following conditions affect car handling and/or a constant right or left lead separate from torque steer causes. The existence of one or more of these conditions may compound a torque steer complaint.

- Incorrect front-wheel alignment or a rear-wheel alignment condition which would cause the car not to track straight. A difference in the front wheel to rear wheel measurement compared side to side may indicate a dog track condition or one front wheel ahead of the other due to frame misalignment or frame misbuild. A substantial caster difference is an indication of frame misalignment or misbuild. Front-wheel caster should be equal and camber may be biased slightly to offset a lead condition.
- Frame misalignment or suspension support misalignment. The GM Body Service Manual, “Underbody”, Section 3, lists measurement points to determine proper frame and underbody alignment, also see Section 2A in this manual.
- Front suspension damage, such as a bent strut.

SEALED WHEEL BEARING DIAGNOSIS

See Figure 25 for Sealed Wheel Bearing Diagnosis.

TAPERED ROLLER BEARING DIAGNOSIS

See Figures 26 and 27 for Tapered Roller Bearing Diagnosis.

TRIM HEIGHT DIAGNOSIS

See Figure 28 for Trim Height Diagnosis.

FRONT WHEEL DRIVE RADIAL TIRE LEAD/PULL CORRECTION

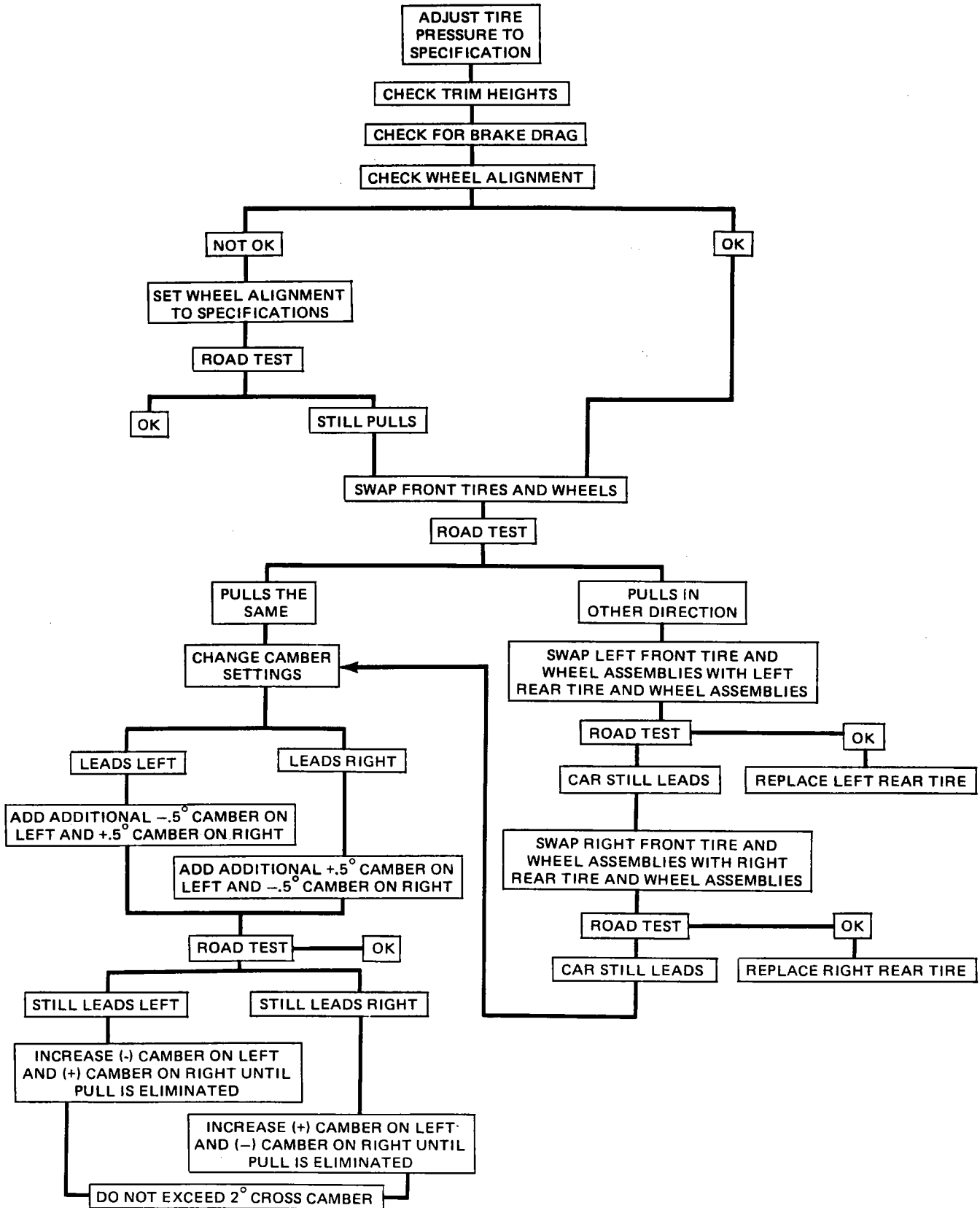

Figure 20 Radial Tire Lead/Pull Diagnosis – Front-Wheel Drive

G33926-3-AN

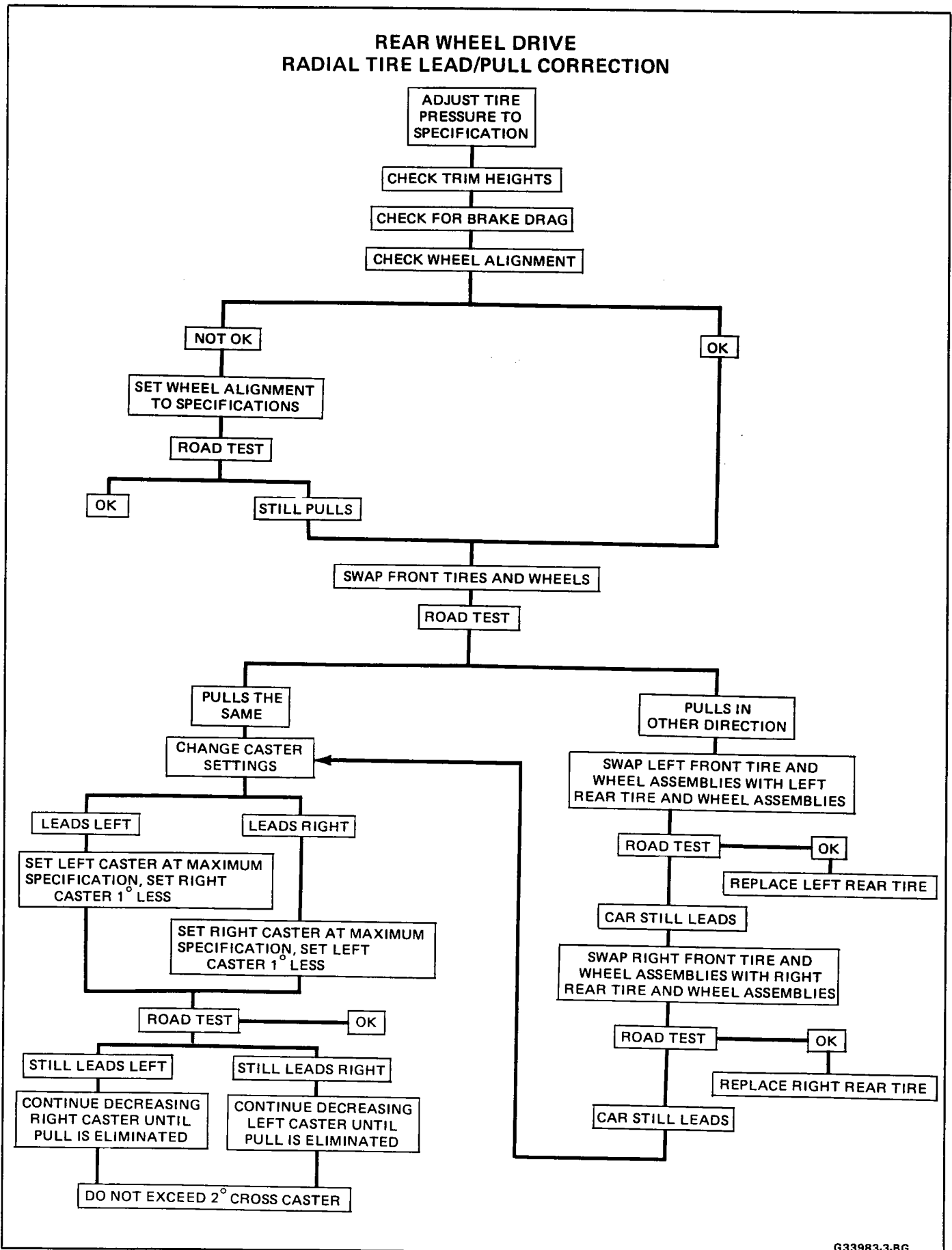
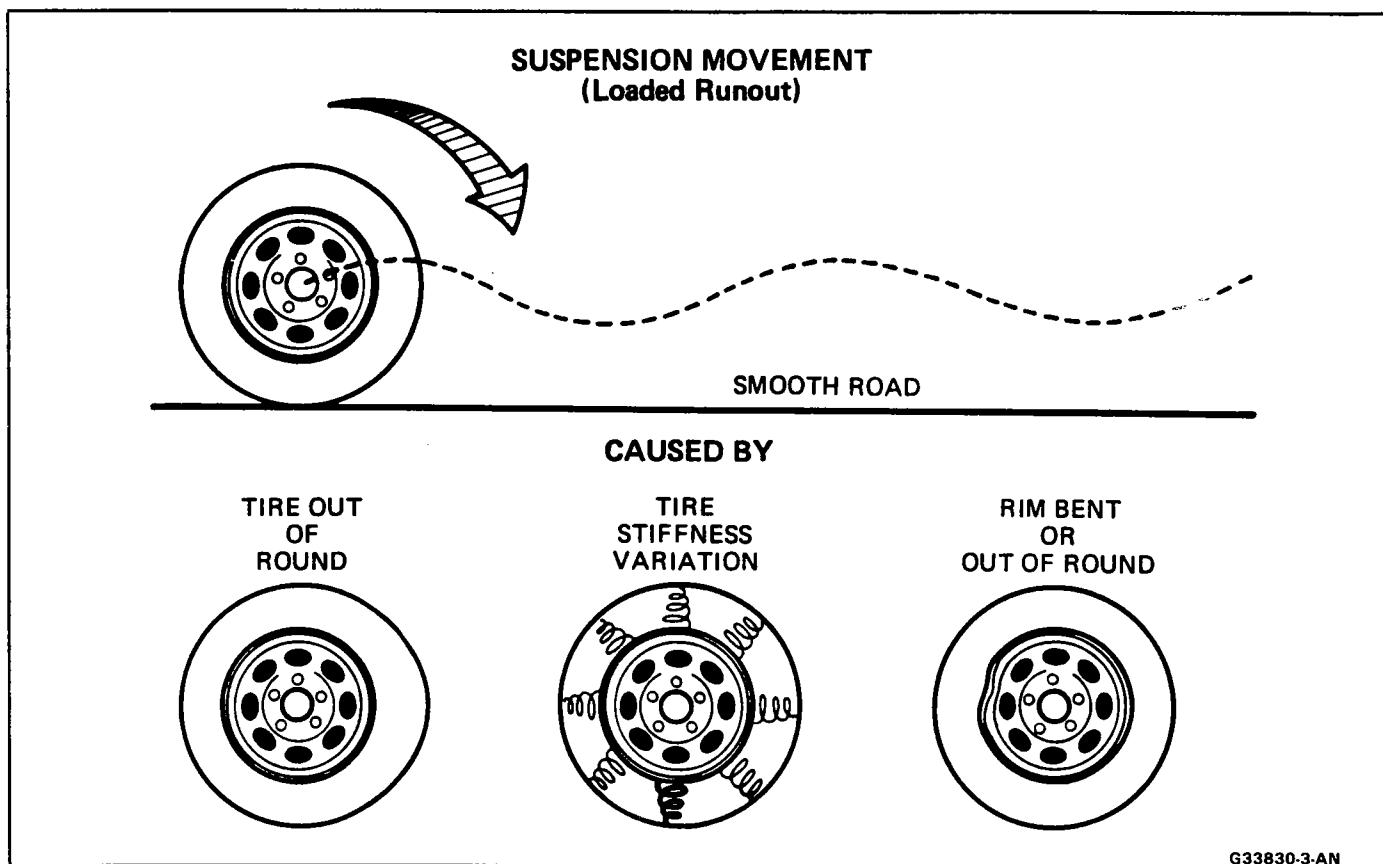

Figure 21 Radial Tire Lead/Pull Diagnosis – Rear-Wheel Drive

G33983-3-BG



G33830-3-AN

Figure 22 Causes of Vibrations

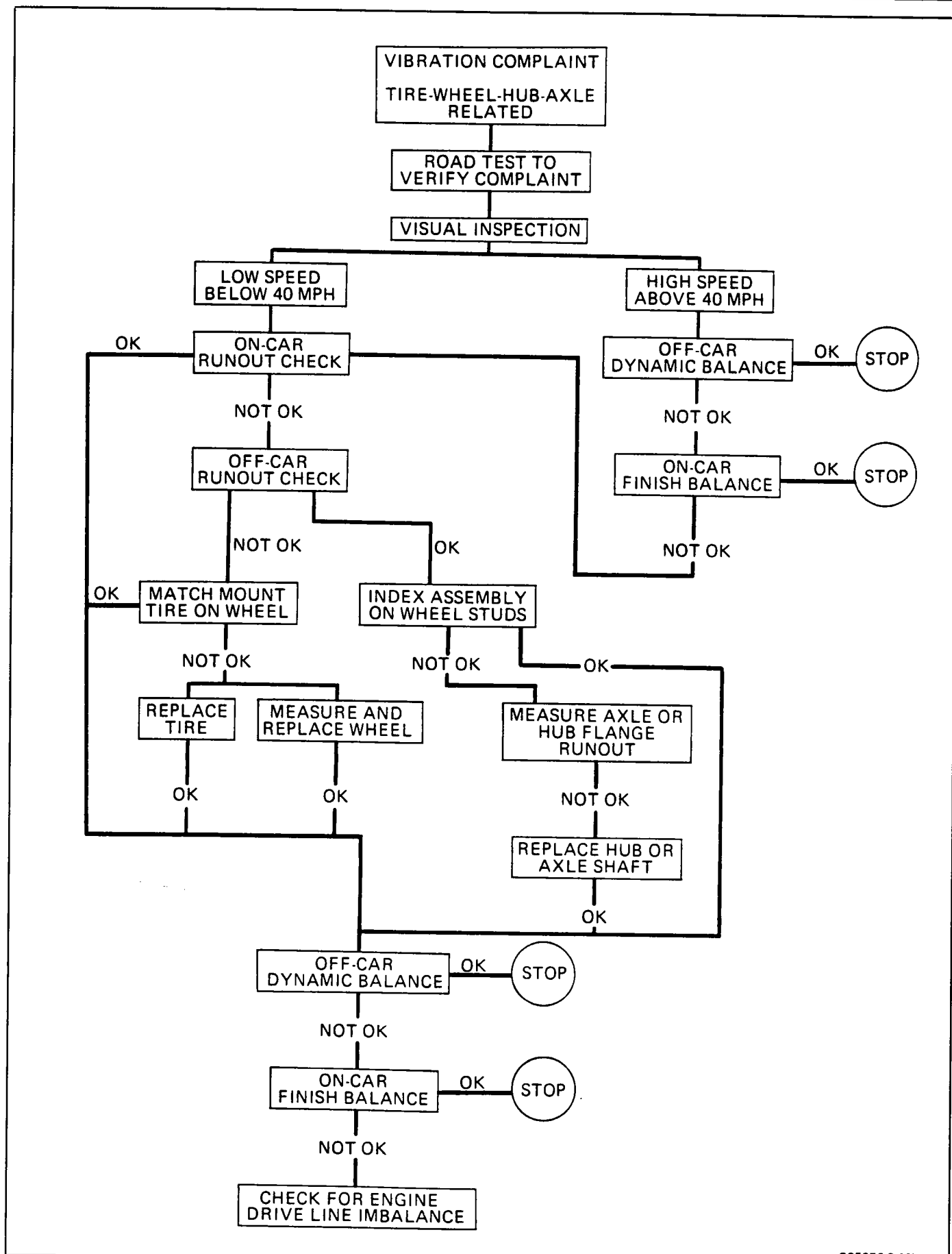

Figure 23 Vibration Complaint Chart (1 of 2)

VIBRATION COMPLAINT TIRE-WHEEL-HUB-AXLE RELATED

Vibrations that are tire or wheel induced can be caused by two factors: imbalance or runout.

Low-speed vibrations, those less than 40 mph, are usually runout related. Highway speed vibrations, those above 40 mph, can be caused by either imbalance or runout.

Prior to performing any work, always road test the car and perform a careful visual inspection for:

- Obvious tire and wheel runout.
- Obvious drive axle or propeller shaft runout.
- Proper inflation pressure.
- Wrong trim height.
- Bent wheels.
- Debris build-up on the tire or wheel.
- Loose or missing wheel weights or wheel nuts.
- Irregular or excessive tire wear.
- Proper tire bead seating on rim.
- Damaged tires, such as tread distortions, separations, or bulges from impact damage. Slight sidewall indentations are normal and will not affect ride quality.

Balance is the easiest procedure to perform and should, therefore, be done first if the vibration occurs at highway speeds. An off-car two-plane dynamic balance should first be performed. This will correct any imbalance in the tire and wheel assembly.

An on-car finish balance may also be required. This will correct any brake drum, rotor, or wheel cover imbalance. Follow the balancing procedures outlined in Section 3E.

If balance does not correct the highway speed vibration, or if the vibration is at low speeds, runout is the probable cause. Runout can be caused by the tire, wheel, or the way the wheel attaches to the car. The following procedure should be used:

A. If runout is suspected, the free runout of the tire and wheel assembly should first be measured on the car. A dial indicator with a roller wheel is preferable, but a dial indicator with button end may be used. Lateral runout (side to side) should be measured on the tire's sidewall as close to the tread shoulder as possible. Radial runout (up and down) should be measured on the center tread rib. Some tread designs may require tightly wrapping a piece of tape around the center tread circumference for better dial indicator contact. For measuring wheel runout follow the "Measuring Wheel Runout" procedure in Section 3E. Whether measuring radial or lateral runout, disregard any instantaneous indicator needle jumps due to sidewall depressions, tread blocks, etc. Record the total indicator reading, and the location of the high point of runout. The total tire and wheel on-car runout should be less than .060", if either measurement exceeds .060", proceed to Step B.

B. If the on-car radial or lateral runout measured in Step A exceeds .060", mount the tire and wheel assembly on a dynamic balance machine and again measure the amount of runout. Locate on the machine by the wheel's inside center pilot hole. Using the same procedure as in Step A, record the amount of tire and wheel runout and its high point location. Next, measure wheel runout, see Section 3E. If the wheel exceeds specifications replace the wheel. If the tire and wheel radial or lateral runout exceeds .050" at the tire tread, proceed to Step C.

C. If the off-car tire and wheel radial or lateral runout measured in Step B exceeds .050", match mount the high radial runout point of tire to low radial runout point of wheel. Reinflate, mount on the dynamic balance machine, and again measure and record the radial and lateral runout and its location, as done in Step B. In many cases, match mounting the tire on the wheel will bring the assembly's runout into the acceptable range of less than .050".

D. If the runout of the tire and wheel assembly is within limits when measured off the car, yet exceeds the limits when measured on the car, the attachment of the tire and wheel assembly to the hub is the probable cause. Rotate the assembly two wheel studs and recheck the runout. Several positions may have to be tried to find the best location.

E. If the assembly runout cannot be reduced to an acceptable level, remove the tire and wheel assembly and measure wheel stud runout with a dial indicator. Zero the dial indicator button on one stud. Lift button gently off stud and rotate flange to position next stud against dial indicator button. Record the runout on all studs. Dial indicator should read zero when repositioned on first stud that was checked. If runout exceeds .030", the hub or axle shaft should be replaced.

Whenever a tire is rotated on the wheel, or a tire or wheel is replaced, the assembly must be rebalanced.

In addition to balance and tire and wheel free runout, tire stiffness variation (loaded radial runout) can also cause a vibration. However, this is impossible to measure without a TPD (Tire Problem Detector) or a loaded radial runout buffer.

The TPD is a roller drum that slowly rotates the tire while under load and mounted on the car. Tire stiffness variation causes wheel spindle movement which can be measured.

The loaded radial runout buffer is a more automated machine that slowly rotates the tire and wheel off the car under load with a roller drum and measures the tire's stiffness variation. It will then "match" the tire to the wheel by buffing off small amounts of rubber from the outer tread rows at the stiff spot. This procedure is usually effective, especially when used as a measuring device and for fine buffing only.

The TPD and loaded radial runout buffer are two methods that will measure or correct tire stiffness variation, tire runout, and wheel runout at the same time. However, because such equipment is not always available, and both have their disadvantages, the more basic procedure of measuring free runout with a dial indicator, as previously detailed, is usually more practical. The free runout of the tire will usually correspond with the tire's stiff spot.

The substitution method of vibration diagnosis can also be used. Install a known good set of tire and wheel assemblies. If these correct the vibration, the original assemblies should be reinstalled one at a time until the vibration returns. This will point out the tire with excess stiffness variation.

Tire stiffness variation will be higher or lower depending on the direction of tire rotation.

SEALED WHEEL BEARING DIAGNOSIS

WHEEL BEARING ASSEMBLY NOISE DIAGNOSIS

If a Road Test indicates noise, it could be wheels, bearings or tires, check the following.

1. Check tires for proper pressure and uneven wear.
2. Raise car on a hoist and spin wheels; check for out-of-round tires, out-of-balance tires, bent rims, loose and/or rough wheel bearings.

SUSPECT BEARING NOISE

OTHER NOISE (CORRECT AS REQUIRED)

FRONT WHEEL BEARING ASSEMBLY

Hoist Car and Support Lower Control and Spin Wheel with Engine.

REAR WHEEL BEARING ASSEMBLY

Hoist Car Spin Wheel with Wheel Spinner

CAUTION: On front wheel drive cars drive wheel spin should be limited to 35 MPH as indicated on the speedometer. This limit is necessary because the speedometer only indicates one-half on the actual wheel speed when one drive wheel is spinning and the other drive wheel is stopped. Unless care is taken in limiting drive wheel spin, the spinning wheel can reach excessive speeds. This can result in possible tire disintegration or differential failure, which could cause serious personal injury or extensive car damage.

NOISE OR ROUGHNESS CAN BE HEARD FROM DRIVER'S SEAT

Replace hub and bearing assembly

NOISE OR ROUGHNESS CAN BE HEARD FROM DRIVER'S SEAT

Replace Hub and Bearing Assembly

NOISE OR ROUGHNESS CANNOT BE HEARD

Noise is not Wheel Bearing Assembly

WHEEL BEARING ASSEMBLY LOOSENESS DIAGNOSIS

DRUM BRAKE

Mount dial indicator as shown below. Grasp bearing flange and, using a push-pull movement, note the indicator readings.

If looseness exceeds .1270 mm (.005"). Replace hub and bearing assembly.

DISC BRAKE

Free the shoes from the disc, or remove calipers. Reinstall 2 wheel nuts to secure disc to bearing. Mount dial indicator as shown below. Grasp disc and use a push-pull movement.

If looseness exceeds .1270 mm (.005"). Replace hub and bearing assembly.

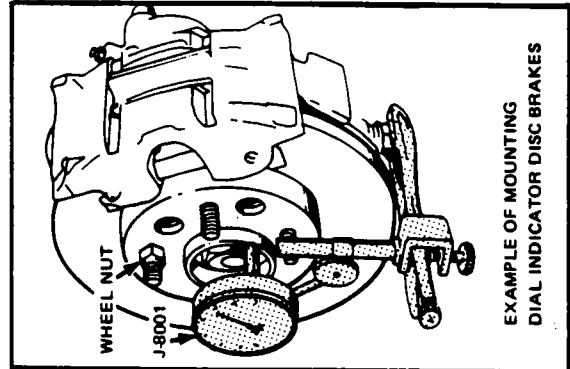
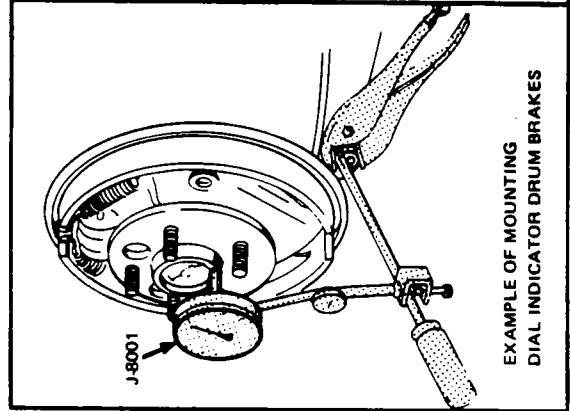





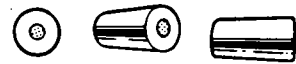



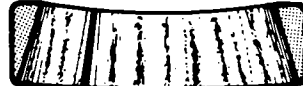



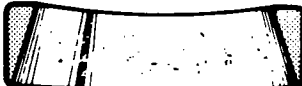





Figure 25 Sealed Wheel Bearing Diagnosis

TAPERED ROLLER BEARING DIAGNOSIS

CONSIDER THE FOLLOWING FACTORS WHEN DIAGNOSING BEARING CONDITION:

1. GENERAL CONDITION OF ALL PARTS DURING DISASSEMBLY AND INSPECTION.
2. CLASSIFY THE FAILURE WITH THE AID OF THE ILLUSTRATIONS.
3. DETERMINE THE CAUSE.
4. MAKE ALL REPAIRS FOLLOWING RECOMMENDED PROCEDURES.

  <p style="text-align: center;">GOOD BEARING</p>	  <p style="text-align: center;">BENT CAGE</p> <p>CAGE DAMAGE DUE TO IMPROPER HANDLING OR TOOL USAGE.</p> <p>REPLACE BEARING.</p>	  <p style="text-align: center;">BENT CAGE</p> <p>CAGE DAMAGE DUE TO IMPROPER HANDLING OR TOOL USAGE.</p> <p>REPLACE BEARING.</p>
  <p style="text-align: center;">GALLING</p> <p>METAL SMEARS ON ROLLER ENDS DUE TO OVERHEAT, LUBRICANT FAILURE OR OVERLOAD.</p> <p>REPLACE BEARING – CHECK SEALS AND CHECK FOR PROPER LUBRICATION.</p>	  <p style="text-align: center;">ABRASIVE STEP WEAR</p> <p>PATTERN ON ROLLER ENDS CAUSED BY FINE ABRASIVES.</p> <p>CLEAN ALL PARTS AND HOUSINGS, CHECK SEALS AND BEARINGS AND REPLACE IF LEAKING, ROUGH OR NOISY.</p>	  <p style="text-align: center;">ETCHING</p> <p>BEARING SURFACES APPEAR GRAY OR GRAYISH BLACK IN COLOR WITH RELATED ETCHING AWAY OF MATERIAL USUALLY AT ROLLER SPACING.</p> <p>REPLACE BEARINGS – CHECK SEALS AND CHECK FOR PROPER LUBRICATION.</p>
  <p style="text-align: center;">MISALIGNMENT</p> <p>OUTER RACE MISALIGNMENT DUE TO FOREIGN OBJECT.</p> <p>CLEAN RELATED PARTS AND REPLACE BEARING. MAKE SURE RACES ARE PROPERLY SEATED.</p>	  <p style="text-align: center;">INDENTATIONS</p> <p>SURFACE DEPRESSIONS ON RACE AND ROLLERS CAUSED BY HARD PARTICLES OF FOREIGN MATERIAL.</p> <p>CLEAN ALL PARTS AND HOUSINGS, CHECK SEALS AND REPLACE BEARINGS IF ROUGH OR NOISY.</p>	  <p style="text-align: center;">FATIGUE SPALLING</p> <p>FLAKING OF SURFACE METAL RESULTING FROM FATIGUE.</p> <p>REPLACE BEARING – CLEAN ALL RELATED PARTS.</p>

G33928-3-BG

Figure 26 Tapered Roller Bearing Diagnosis (1 of 2)

TAPERED ROLLER BEARING DIAGNOSIS - CONT'D

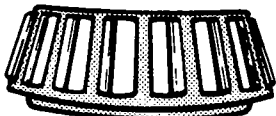
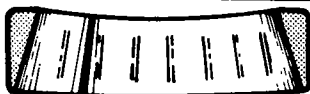

BRINELLING

SURFACE INDENTATIONS IN RACEWAY CAUSED BY ROLLERS EITHER UNDER IMPACT LOADING OR VIBRATION WHILE THE BEARING IS NOT ROTATING.

REPLACE BEARING IF ROUGH OR NOISY.



CAGE WEAR

WEAR AROUND OUTSIDE DIAMETER OF CAGE AND ROLLER POCKETS CAUSED BY ABRASIVE MATERIAL AND INEFFICIENT LUBRICATION. CHECK SEALS AND REPLACE BEARINGS.



ABRASIVE ROLLER WEAR

PATTERN ON RACES AND ROLLERS CAUSED BY FINE ABRASIVES.

CLEAN ALL PARTS AND HOUSINGS, CHECK SEALS AND BEARINGS AND REPLACE IF LEAKING, ROUGH OR NOISY.

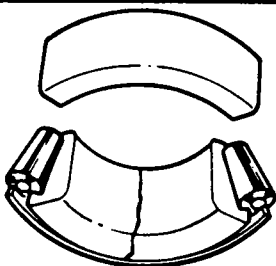

CRACKED INNER RACE

RACE CRACKED DUE TO IMPROPER FIT, COCKING, OR POOR BEARING SEATS.

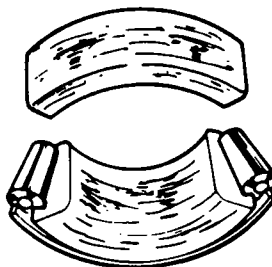

SMEARS

SMEARING OF METAL DUE TO SLIPPAGE, SLIPPAGE CAN BE CAUSED BY POOR FITS, LUBRICATION, OVERHEATING, OVERLOADS OR HANDLING DAMAGE.

REPLACE BEARINGS, CLEAN RELATED PARTS AND CHECK FOR PROPER FIT AND LUBRICATION.

REPLACE SHAFT IF DAMAGED.

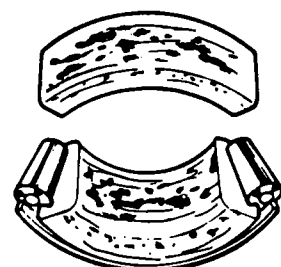

FRETTAGE

CORROSION SET UP BY SMALL RELATIVE MOVEMENT OF PARTS WITH NO LUBRICATION.

REPLACE BEARING. CLEAN RELATED PARTS. CHECK SEALS AND CHECK FOR PROPER LUBRICATION.

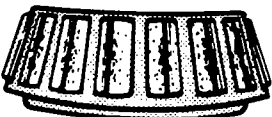
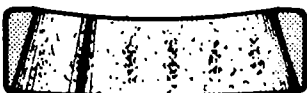

HEAT DISCOLORATION

HEAT DISCOLORATION CAN RANGE FROM FAINT YELLOW TO DARK BLUE RESULTING FROM OVERLOAD OR INCORRECT LUBRICANT.

EXCESSIVE HEAT CAN CAUSE SOFTENING OF RACES OR ROLLERS.

TO CHECK FOR LOSS OF TEMPER ON RACES OR ROLLERS A SIMPLE FILE TEST MAY BE MADE. A FILE DRAWN OVER A TEMPERED PART WILL GRAB AND CUT METAL, WHEREAS, A FILE DRAWN OVER A HARD PART WILL GLIDE READILY WITH NO METAL CUTTING.

REPLACE BEARINGS IF OVER HEATING DAMAGE IS INDICATED. CHECK SEALS AND OTHER PARTS.

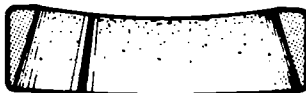

STAIN DISCOLORATION

DISCOLORATION CAN RANGE FROM LIGHT BROWN TO BLACK CAUSED BY INCORRECT LUBRICANT OR MOISTURE.

RE-USE BEARINGS IF STAINS CAN BE REMOVED BY LIGHT POLISHING OR IF NO EVIDENCE OF OVERHEATING IS OBSERVED.

CHECK SEALS AND RELATED PARTS FOR DAMAGE.

Figure 27 Tapered Roller Bearing Diagnosis (2 of 2)

Trim heights checked with correct tire pressures, fuel tank full or equivalent weight in the trunk. No passengers or added weight in car. Front seat in rear position. Trunk must be empty except for spare tire and jack or simulated fuel load. Measure from known level floor to rocker panel with steering wheel in the centered position.

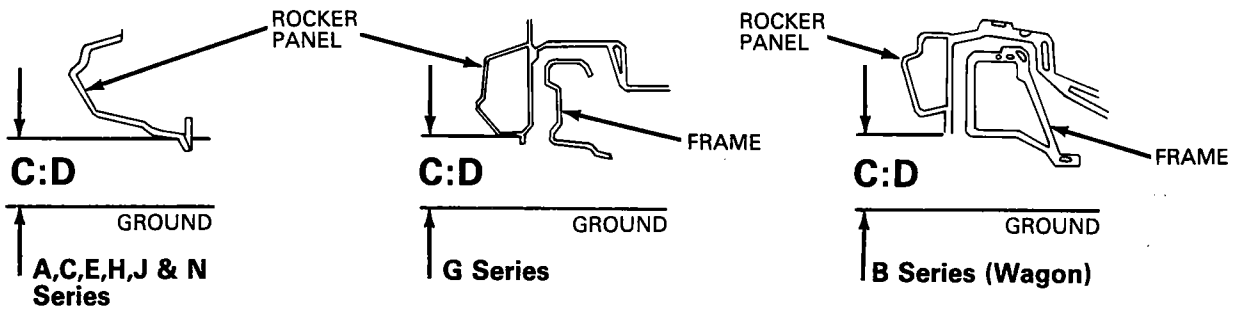
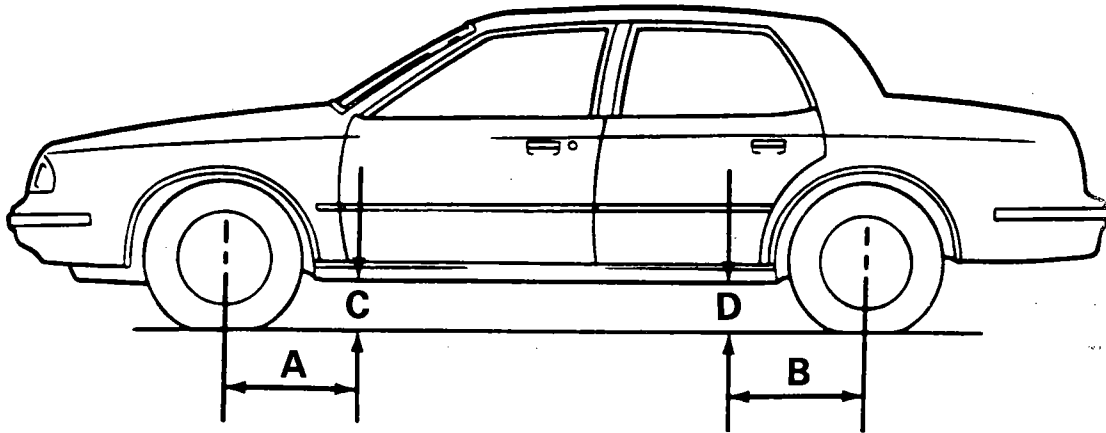

C & D DIMENSION

Lift center of front bumper up approximately 38 mm (1-1/2") and let vehicle settle gently. Repeat two more times, then measure "C" dimension. Push center of bumper down 38 mm (1-1/2") and let vehicle settle gently. Repeat two more times, then measure "C" dimension. The "C" dimension is an average of the high and low measurements. Repeat procedure on the rear bumper for the "D" dimension.

MAXIMUM VARIATION SIDE TO SIDE AND FRONT TO REAR IS 19 mm (3/4")

	A	B	C	D
A Series Coupe - Sedan Wagon	505 (19 7/8)	459 (18 1/16)	231 (9 3/32) 233 (9 11/64)	233 (9 11/64) 238 (9 3/8)
B Series Wagon	710 (27 61/64)	488 (19 7/32)	265 (10 7/16)	268 (10 35/64)
C Series	600 (23 5/8)	600 (23 5/8)	242 (9 3/8)	250 (9 7/16)
E Series	580 (22 27/32)	563 (22 5/32)	208 (8 1/4)	202 (8 3/16)
G Series	623 (24 33/64)	532 (20 15/16)	252 (9 7/8)	262 (9 7/8)
H Series	600 (23 5/8)	600 (23 5/8)	242 (9 13/32)	255 (9 11/16)
J Series Coupe - Sedan Wagon	557 (21 15/16)	554 (21 13/16)	241 (9 31/64) 246 (9 11/16)	238 (9 3/8) 250 (9 27/32)
N Series	557 (21 15/16)	560 (22 3/64)	243 (9 13/32)	245 (9 7/32)

Specifications are in millimeters & (inches)

Figure 28 Trim Height Diagnosis